

# U.S. CONSUMER PRODUCT SAFETY COMMISSION



## ENGINE-DRIVEN TOOLS

### PHASE 2 TEST REPORT: PORTABLE GENERATOR EQUIPPED WITH A SAFETY SHUTOFF DEVICE

Originally prepared July 2008  
(Released July 2013)

Prepared by Christopher J. Brown  
Directorate for Laboratory Sciences  
Gaithersburg, MD 20878

This report was prepared by CPSC staff, has not been reviewed or approved by, and may not necessarily reflect the views of, the Commission.

## PREFACE

CPSC staff conducted the Phase 2 test program described in this report in late 2005, very early in the overall portable generator program. Its goals were to: (1) determine if the concept of a CO sensor/alarm output signal from commercially available residential CO alarms (meeting the requirements in UL 2034 *Single and Multiple Carbon Monoxide Alarms*) could trigger a shutoff device installed on a portable generator, and (2) measure CO concentrations around the generator when operated in multiple environments to assess CO migration and levels that might occur under several scenarios. Test environments examined included outdoors, in a two-sided structure, and in and under a temporary modular storage (TMS) building. The TMS consists of a single-zone unconditioned rectangular space approximately 15 m (49 ft) long, 7.0 m (23 ft) wide, and 2.7 m (9 ft) high with eight windows, one entrance doorway, and a roll-up (bay) door that was approximately 2.03 m (6 ft 8 in) high and 1.96 m (6 ft 5 in) wide.

While the data show that an alarm output from a residential CO alarm triggered a circuit on a prototype safety shutoff device (SSD) that turned off a portable generator, observations from the data indicate that there were a number of product design elements that posed significant challenges to developing a robust system beyond this initial concept demonstration. These design elements included aspects such as reliability, placement, and redundancy. For instance, the CO concentration data and alarm activation times at various locations in the test areas and on the generator itself reveal that shutoff systems sensing CO concentrations only at the generator would not be protective in many situations. Results from Test 1b.1 conducted outdoors away from buildings where alarms were located 5 feet and 10 feet away from the generator experienced concentrations up to 500 ppm and activated, but none of the alarms on the SSD mounted on the generator activated although CO concentrations up to 180 ppm were measured beside the generator. As another example, when the generator operated inside the TMS, Table 6: *Summary of CO Alarm and SSD Shutoff Times* shows that although the on-board SSD activated to shut off the generator, CO levels in some parts of the structure reached up to 1,000 ppm before activation. As a result, the attached report states, in part, “this study does not suggest CO sensors or alarms placed on or placed near the generator as a suitable solution.”

The testing was intended to assess the potential feasibility of using an SSD; however, it was not intended as a comprehensive testing program to assess all potential SSD integration issues. The results from this work were used to support staff’s efforts that were initiated in 2006, after completion of this initial study. Based in part on the assessment of this data and the challenges that would be involved to develop a robust SSD approach, CPSC staff determined that a more appropriate approach would be to reduce the hazard at the source by substantially reducing the engine’s CO emission rate. The emission reduction strategy will not only help to reduce the hazard for those who, either knowingly or unknowingly expose themselves to the risk of CO poisoning by operating a generator in an indoor location, but will also help to protect those who are making a conscious effort to use the product properly in an outdoor location. CPSC staff has also examined other shutoff strategies beyond the work presented in this report and found that the challenges identified in this study regarding reliability, as well as other factors, still would need addressing. CPSC staff views any shutoff sensor/device strategy as one that would serve to supplement a primary strategy of reduced emissions.

## TABLE OF CONTENTS

|  |                                     |
|--|-------------------------------------|
| <b>EXECUTIVE SUMMARY .....</b>                                 | <b>1</b>                            |
| <b>1 INTRODUCTION AND OBJECTIVES .....</b>                     | <b>2</b>                            |
| <b>2 TEST EQUIPMENT AND FACILITIES .....</b>                   | <b>2</b>                            |
| <b>2.1 GENERATOR .....</b>                                     | <b>2</b>                            |
| <b>2.2 AUTOMATIC CO SAFETY SHUTOFF DEVICE (SSD) .....</b>      | <b>2</b>                            |
| <b>2.3 TEST FACILITIES .....</b>                               | <b>5</b>                            |
| <b>2.4 INSTRUMENTATION .....</b>                               | <b>7</b>                            |
| <b>2.5 DATA ACQUISITION SYSTEMS .....</b>                      | <b>9</b>                            |
| <b>3 TEST CONDITIONS, SCENARIOS &amp; PROCEDURES .....</b>     | <b>9</b>                            |
| <b>3.1 TEST CONDITIONS .....</b>                               | <b>9</b>                            |
| <b>3.2 TEST SCENARIOS .....</b>                                | <b>10</b>                           |
| <b>3.3 PRE-TEST SETUP .....</b>                                | <b>11</b>                           |
| <b>3.4 TEST PROCEDURES FOR GENERATOR OPERATION .....</b>       | <b>16</b>                           |
| <b>3.5 AIR EXCHANGE RATE TEST .....</b>                        | <b>16</b>                           |
| <b>4 DATA ANALYSIS .....</b>                                   | <b>17</b>                           |
| <b>4.1 CO ALARMS AND SENSOR DATA .....</b>                     | <b>17</b>                           |
| <b>4.2 AIR EXCHANGE RATE DATA ANALYSIS .....</b>               | <b>17</b>                           |
| <b>5 GENERATOR TEST RESULTS .....</b>                          | <b>19</b>                           |
| <b>5.1 PRE-SSD TESTS .....</b>                                 | <b>19</b>                           |
| <b>5.2 TESTS WITH SSD .....</b>                                | <b>26</b>                           |
| <b>5.3 CO SENSOR DATA .....</b>                                | <b>30</b>                           |
| <b>6 DISCUSSION OF TEST RESULTS .....</b>                      | <b>33</b>                           |
| <b>7 ACKNOWLEDGMENTS .....</b>                                 | <b>ERROR! BOOKMARK NOT DEFINED.</b> |
| <b>8 REFERENCES .....</b>                                      | <b>35</b>                           |
| <b>APPENDIX A: TEST FACILITIES PHOTOS AND SCHEMATICS .....</b> | <b>36</b>                           |
| <b>APPENDIX B: CHAMBER TEST EQUIPMENT .....</b>                | <b>42</b>                           |
| <b>APPENDIX C: SELECTED TEST DATA CHARTS .....</b>             | <b>43</b>                           |
| <b>APPENDIX D: CO ALARM AND CO SENSOR TESTS .....</b>          | <b>54</b>                           |

## LIST OF FIGURES

|   |    |
|---|----|
| Figure 1: Schematic of Automatic CO Safety Shutoff Device (SSD) .....   | 3  |
| Figure 2: Automatic CO Safety Shutoff Device Control Box .....  | 4  |
| Figure 3: Automatic CO Safety Shutoff Device: Control Box with Three Model 1 CO Alarms Connected .....  | 5  |
| Figure 4: Generator Test Areas (Generator Location Highlighted in Red).....   | 6  |
| Figure 5: Typical CO Alarm used to measure the CO concentration during generator testing .....  | 7  |
| Figure 6: Typical CO Sensor Positioned Around the Test Area .....   | 8  |
| Figure 7: Comparison of the Severity of Generator Tests .....   | 11 |
| Figure 8: Plan View: Setup for Outdoor Tests Conducted in Center of Parking Area .....  | 12 |
| Figure 9: Plan View: Setup for Outdoor Tests Conducted under Two-Sided Roofed Shelter Beside TMS.....   | 13 |
| Figure 10: Plan View: Setup for Tests Conducted Inside TMS.....   | 14 |
| Figure 11: Elevation View: Setup for Tests Conducted Under TMS in Crawlspace.....   | 15 |
| Figure 12: Plan View Inside TMS: Legend Showing Location of CO Sensors and CO Alarms and Where<br>AER Calculations Were Performed.....  | 15 |
| Figure 13: Test 1a.3, CO Concentrations on Two Sides at a Distance of Approximately 7.6 to 15.2 cm (3 to 6<br>Inches) from the Generator, 7/19/05, Tested in the Middle of Courtyard..... | 21 |
| Figure 14: Test 1a.3, CO Alarm Peak Readings at a Height of 1.07 m (3 ft 6 in) Above the Ground around<br>the Generator, 7/19/05, Tested in the Middle of the Courtyard.....              | 22 |
| Figure 15: Test 1a.3, CO Alarm Peak Readings at a Height of 1.68 m (5 ft 6 in) Above the Ground around the<br>Generator, 7/19/05, Tested in the Middle of the Courtyard.....              | 23 |
| Figure 16: Test 3a.1, Roll-up Door & Vents Open, 10/03/05, Generator in TMS.....  | 25 |
| Figure 17: Test 4a.3, Roll-up Door & Vents Closed, 10/06/05, Generator in TMS .....   | 26 |
| Figure 18: SSD Test (3b.1), Roll-Up Door & Vents Open, 10/20/05, Generator in TMS .....   | 29 |
| Figure 19: SSD Test (4b.3) Roll-Up Door & Vents Closed, 10/14/05, Generator in TMS .....  | 30 |

## LIST OF TABLES

|  |    |
|--|----|
| Table 1: Performance Specifications of Generator B .....   | 2  |
| Table 2: Generator Tests .....   | 10 |
| Table 3: Half-Life for CO Concentration Inside a Room at Various ACHs.....                               | 18 |
| Table 4: Outdoor Pre-SSD Tests: CO Alarm Summary .....   | 20 |
| Table 5: TMS Pre-SSD Tests: CO Alarm Summary .....   | 24 |
| Table 6: Summary of CO Alarm and SSD Shutoff Results.....  | 28 |
| Table 7: Summary of Gas Concentrations for Tests with CO Sensors and Portable Analyzers.....             | 31 |
| Table 8: Localized ACHs from Five Locations in the TMS for the Four Tests Presented in Figures 16 to 19. | 32 |

## EXECUTIVE SUMMARY

In 2004, U.S. Consumer Product Safety Commission (CPSC) staff completed testing of four sample portable electric generators to determine the rates at which the generators produced carbon monoxide (CO) under various operating conditions (Phase 1 testing)(Brown, 2006). The purpose of the Phase 1 testing was to characterize the health hazard posed by various models of portable electric generators. Results from the Phase 1 testing indicated that a typical engine generator available to consumers could cause the accumulation of lethal amounts of CO in a relatively short period of time (Inkster, 2004) when used in an enclosed space.

As a follow-on activity, staff conducted testing to explore options for reducing the risk associated with portable electric generators by integrating a gas-sensing safety shutoff device (SSD) that could shut off a generator when the ambient CO reached a threshold limit (Phase 2 testing). In Phase 2, staff tested one generator, Generator B (5.5 kW continuous power rating), from Phase 1 of the Engine-Driven Tools Project. Goals included investigating how: (1) an off-the-shelf CO alarm could be used to shut down a generator and limit the accumulation of CO in the generator operating space, and (2) the normal CO concentrations produced by a generator under several indoor and outdoor scenarios build up. Tests were conducted indoors and outdoors at the CPSC Laboratory campus under ambient environmental conditions. For some tests, a safety shutoff device (SSD) was installed on the generator to shut off the generator when hazardous conditions were detected. In addition, to monitor CO levels and conditions throughout the test area and around the generator, off-the-shelf residential CO alarms, CO sensors, portable analyzers, and cameras were used.

When testing in the Temporary Modular Storage (TMS) building with the doors and vents closed, the maximum CO concentration measured inside was approximately 1,000 ppm with the SSD installed versus approximately 5,900 ppm when the SSD was not used. The CO concentration was continuing to increase when the test was terminated, indicating CO concentrations would have been much higher than 5,900 ppm had the generator not been turned off by staff.

The test results showed that the generator produced CO concentrations that were:

- sufficient to activate CO alarms located 1.51 m (5 ft) away from the generator in 19 minutes, and 3.05 m (10 ft) away in 44 minutes when tested outdoors;
- sufficient to activate CO alarms located in a single room building (TMS) within 20 minutes even when the engine exhaust is directed out of the building through an open roll-up door;
- sufficient to cause CO alarms mounted on the generator to activate within 29 minutes when the generator was run outdoors in a two-sided roofed structure or in a crawl space within 13 min; and
- potentially lethal because CO concentrations may remain in an enclosed space after an SSD (based on current CO alarms sensor requirements) shuts-off a generator, depending on the enclosure size, ventilation, and other environmental conditions.

An SSD incorporating several current “off-the-shelf” CO alarms was able to shut off a generator in a test environment.

## 1 INTRODUCTION AND OBJECTIVES

According to U.S. Consumer Product Safety Commission (CPSC) records, during the years 1999 through 2006, 334 deaths resulted from carbon monoxide (CO) poisoning associated with generator use (Marcy & Ascone, 2005; Hnatov, 2007). As part of the effort to address this hazard, in 2004, CPSC staff completed testing of four sample portable gasoline-powered generators to determine the rate at which the generators produce CO under various operating conditions (Phase 1 testing) (Brown, 2006).

As a follow-on to that effort, in 2005, CPSC staff completed additional (Phase 2) testing to:

- 1) determine if an off-the-shelf CO alarm could be used to shut down a generator, thereby limiting the accumulation of CO in the generator operating space; and
- 2) measure the normal CO concentrations produced by a generator under several indoor and outdoor operating scenarios.

This report presents the results of CPSC staff's Phase 2 testing program.

## 2 TEST EQUIPMENT AND FACILITIES

### 2.1 Generator

In CPSC staff's Phase 1 testing program, four "off-the-shelf" engine generators (A, B, C, and D) were tested to determine the rate at which the generators produce CO. The generator that produced the highest CO generation rate, Generator B, was selected for Phase 2 testing. Table 1 lists the performance specifications for Generator B.

**Table 1: Performance Specifications of Generator B**

| Generator Designation | Engine   | AC Output   | DC Output      | Fuel Tank (Gallons) | Dry Weight (lbs) |
|-----------------------|--|---|----------------|---------------------|------------------|
| Generator B           | <ul style="list-style-type: none"><li>• 10 HP</li><li>• Single cylinder</li><li>• Overhead valve</li><li>• Air cooled</li><li>• 4-stroke, gasoline</li></ul> | <ul style="list-style-type: none"><li>• 120/240 Volts</li><li>• 60 hertz</li><li>• 8500 watts (max surge)</li><li>• 5500 watts (nameplate rated load)</li></ul> | Not applicable | 5                   | 148              |

An adjustable capacity resistive load bank (200 Amp @ 240 Volts AC/DC, Manufacturer: Gus Berthhold Electric Co.) was used to provide the electrical load on the generator during a test.

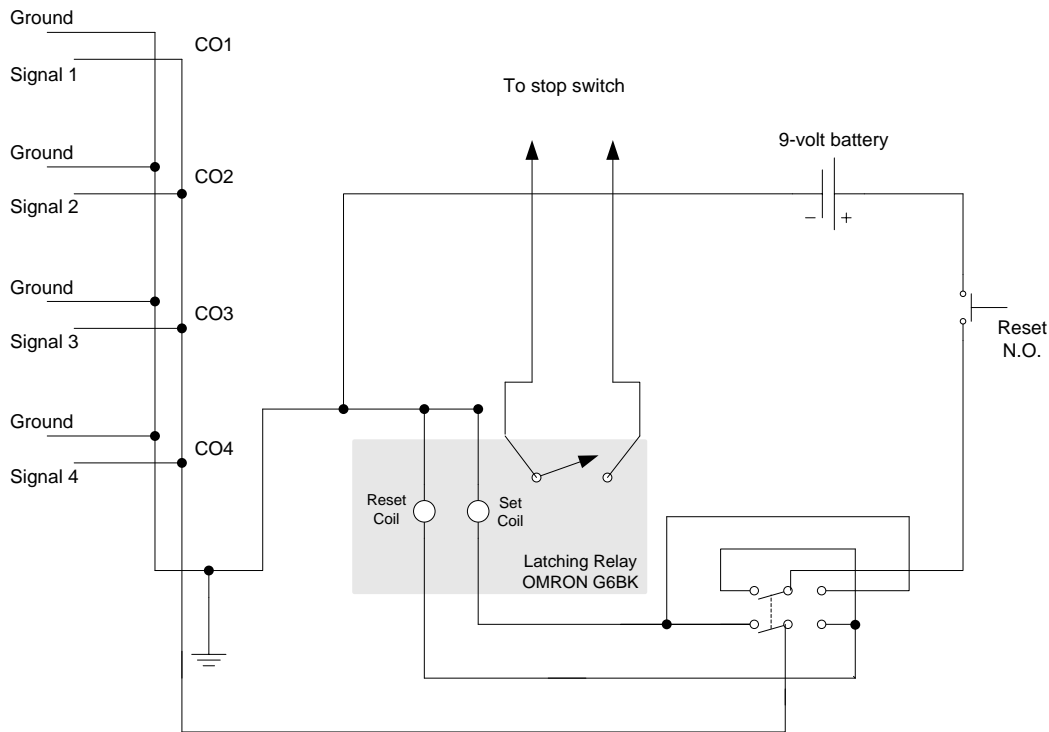
### 2.2 Automatic CO Safety Shutoff Device (SSD)

A prototype safety shutoff device (SSD) was developed by CPSC staff to shut off the generator when a hazardous concentration of CO was detected. The SSD consists of three residential-type CO alarms and circuitry to interface the CO alarms with the generator. In staff's design, the SSD can accommodate up to four CO alarms, although the SSD could be designed to accommodate any number of CO alarms. In addition, once the SSD activates, the generator cannot be restarted, unless the operator resets the shutoff circuit.

Figure 1 shows a schematic of the safety shutoff circuit, which includes the following components:

- an OMRON G68K latching relay,
- a 9-volt battery,

- a momentary-contact switch (for the reset button), and
- a double-pole double-throw (toggle) switch.



**Figure 1: Schematic of Automatic CO Safety Shutoff Device (SSD)**

The following describes the operation of the SSD:

When a CO alarm activates, it outputs a pulsed voltage (which activates a flashing LED and produces an audible alarm). The first activated alarm will energize the “set” coil of the circuit’s latching relay. In response, the relay’s contacts, which are in parallel to the generator’s stop switch, will close, thereby removing the ignition voltage to the generator spark plug and stopping the generator. This set-up also allows the generator to be stopped manually. The latching relay will stay engaged, preventing the generator from restarting. The operator can reset the shutoff circuit (using the “RESET” button), thereby allowing the generator to be restarted.

A toggle switch makes the circuit adaptable to the methods for stopping the generator. One method is to remove power to the spark plug. Setting the toggle switch so the main contacts will open when alarming will remove power to the spark plug. The other method is to ground the energy to the spark plug. Setting the toggle switch so the main contacts are closed when the alarm sounds will cause the spark plug to be grounded. For these tests, the ground of the spark plug method was used.

Figure 2 shows the assembled SSD control box, which is approximately 14 cm x 5 cm x 7.6 cm (5½ in x 2 in x 3 in). The “RESET” button (which resets the latching relay) and the connections for up to four CO alarms (Model 1) are located on the front of the control box. Connections to the generator’s “stop switch” and to the toggle switch for selecting the type of generator connection (normally open or normally closed) are located on the right side of the SSD.





**Figure 2: Automatic CO Safety Shutoff Device Control Box**

The CO alarms used in the SSD were standard off-the-shelf residential CO alarms. These CO alarms will be referred to as Model 1 CO alarms in this report. Features of the Model 1 CO alarms were as follows: electrochemical technology sensors, digital displays showing the CO concentration, capability to record/display the maximum CO concentration to which the alarm was exposed between resets, reset/test feature, and battery back-up power. The alarms were listed to Underwriters Laboratories Inc. (UL) *Standard for Safety for Single and Multiple Station Carbon Monoxide Alarms* (UL 2034, June 2002). The sensitivity requirement<sup>1</sup> in the UL standard requires CO alarms to activate under the following conditions<sup>2</sup>:

- exposure to sustained CO levels of 70 parts per million (ppm), must activate within 60–240 minutes;
- exposure to sustained CO levels of 150 ppm, must activate within 10–50 minutes; and
- exposure to sustained CO levels of 400 ppm must activate within 4–15 minutes.

Appendix D discusses how the Model 1 CO alarms were checked to verify that they were functioning properly. Figure 3 is a photograph showing three Model 1 CO alarms connected to the SSD control box.

---

<sup>1</sup> Section 38, UL 2034, June 28, 2002.

<sup>2</sup> Generally, these exposure times and concentrations are consistent with the 10 percent carboxyhemoglobin (COHb) concentrations, as defined by the simplified linear Coburn-Foster-Kane Equation (Steinberg, S. and Neilson, G.D., 1997), defined at high activity levels for healthy adults.



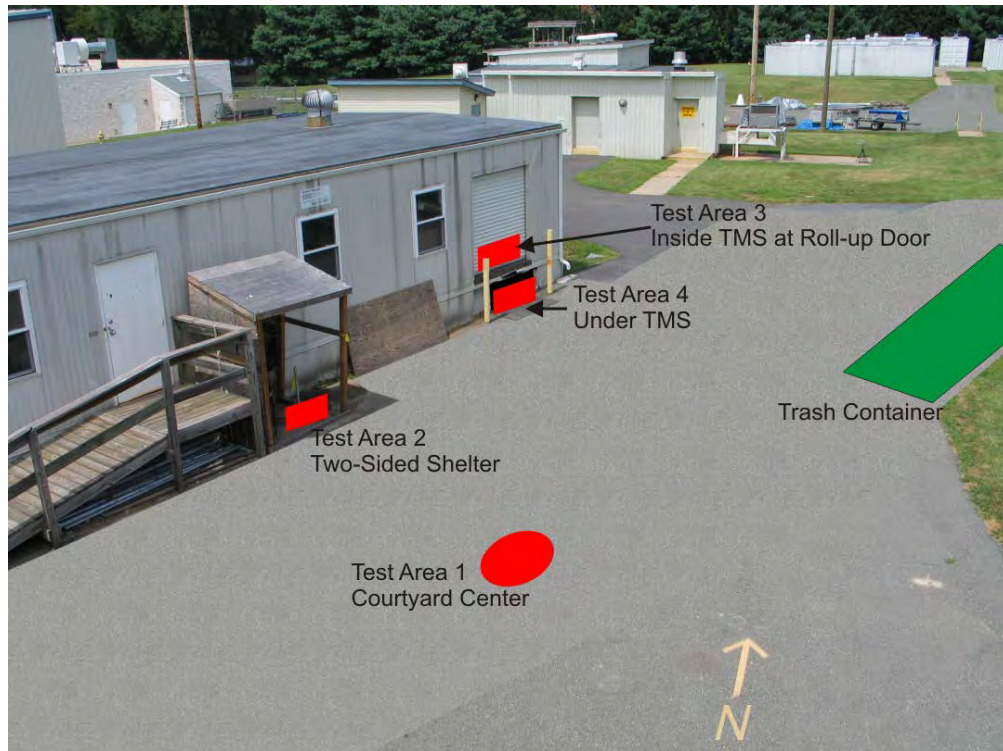
**Figure 3: Automatic CO Safety Shutoff Device: Control Box with Three Model 1 CO Alarms Connected**

### 2.3 Test Facilities

Staff performed generator tests in five locations at the CPSC laboratory in Gaithersburg, MD. Figure 4 shows four of the five test areas. Additional photographs of the test areas and test set-ups are included in Appendix A. In addition, staff conducted tests in an environmental chamber (known as the Medium Chamber, or M Chamber). Photographs of the M Chamber and the test set-up are also shown in Appendix A.

**Test Area 1: Outdoor Parking Area** - The area is surrounded by an L-shaped building on two sides and a temporary modular storage (TMS) building on a third side. The area is a little more than 10.7 meters (m) (35 feet (ft) wide and opens to the campus on one side. Staff placed the generator in the center of the area, approximately 5.2 m (17 ft) from the closest large building. A large trash bin was also present in the upper right area (see Figure 4 for the general location of the trash bin) of the courtyard during testing.

**Test Area 2: Two-Sided Roofed Shelter** - The partial enclosure is a two-sided structure that has a sloped roof and is approximately 1.83 m (6 ft) wide, 1.52 m (5 ft) deep, 2.44 m (8 ft) tall at the rear and 2.13 m (7 ft) tall at the front. One wall of the structure is adjacent to the wall of the TMS building, and the other is adjacent to the entrance ramp to the TMS.



**Figure 4: Generator Test Areas (Generator Location Highlighted in Red)**

**Test Area 3: Temporary Modular Storage (TMS) Building** - The TMS is a rectangular building with one single room above a crawl space; the building has a slightly peaked ceiling. The internal dimensions of the building are approximately 15 m (49 ft) long, 7.0 m (23 ft) wide, and 2.7 m (9 ft) high. The internal volume is approximately 283 m<sup>3</sup> (10,000 ft<sup>3</sup>). Approximately 40 percent of the volume was displaced by equipment stored in the TMS. The building does not contain any heating or cooling systems. Mixing of building air occurs by natural convection. The building has eight windows (three on the front side [facing courtyard] and five on the back), one standard-sized door, one roll-up (bay) door that is approximately 2.03 m (6 ft 8 in) high and 1.96 m (6 ft 5 in) wide, and two convection/wind-powered through-the-roof ventilators.<sup>3</sup>

**Test Area 4: Crawl Space Under TMS** - The crawl space under the TMS building is approximately 0.9 m (3 ft) high and extends the full length and width of the building (approximately 15 m (49 ft) long and 7.0 m (23 ft) wide). Concrete masonry unit columns support the building's steel subfloor structural frame in the crawl space. The crawl space is enclosed around the perimeter with sheets of steel siding.

**Test Area 5: M-Chamber** – The test chamber is a modified environmental room manufactured by Hotpack (Appendix A: Figure A5). The internal dimensions of the chamber are approximately 2.44 m (8 ft) wide by 1.83 m (6 ft) deep by 2.18 m (7 ft 2 in) high. The gross internal volume of the chamber is approximately 9.71 m<sup>3</sup> (343 ft<sup>3</sup>) (Brown, 2004). Exhaust piping, heat exchangers, lights, and other items occupy space inside the chamber. The net internal chamber volume is approximately 9.59 m<sup>3</sup> (339 ft<sup>3</sup>).

<sup>3</sup> Significant figures differ because the accuracy of the measurement differs between the building and the door.

## 2.4 Instrumentation

### 2.4.1 Outdoor and TMS Locations

During generator testing outdoors and in the TMS, the CO concentration was measured at various locations using a combination of residential CO alarms, CO sensors, and portable handheld gas analyzers.

The CO alarms used in the measurement of the CO concentration were standard off-the-shelf residential CO alarms. For this report, these CO alarms will be referred to as Model 2 CO alarms. The CO alarms are listed to UL 2034 (June 2002), they use an electrochemical technology sensor, and they have a digital display showing the CO concentration. The CO alarms also record/display the maximum CO concentration detected by the alarm. The maximum CO concentration that the CO alarm can display is 999 ppm. The Model 2 CO alarm does not provide any type of analog output for data collection of the CO concentration. Therefore, the display on the unit must be monitored in order to know the CO concentration at any given time. If the display could not be observed safely, then a video camera was used. Figure 5 shows a Model 2 CO alarm, which differs slightly in appearance from the Model 1 CO alarm that was used with the SSD (shown previously in Figure 3). Appendix D discusses how the Model 2 CO alarms were checked to verify that they were functioning properly.



**Figure 5: Typical CO Alarm used to measure the CO concentration during generator testing**

Staff also used CO sensors to record the CO concentrations during each test. The CO sensors use electrochemical technology to determine CO concentrations, and the sensors are each approximately 5.1 cm (2 inch) in diameter and 2.5 cm (1 inch) deep. Staff used 24 CO sensors throughout the test program, although only 22 of the sensors were employed at any time. Twelve sensors have a specified range of 0 to 2,000 ppm (low range); and 12 sensors have a specified range of 0 to 20,000 ppm (high range). The CO sensors were capable of generating a 0-2 volt analog output signal, which varied linearly with the CO concentration.<sup>4</sup> Therefore, the CO concentration data could be recorded continuously with a data acquisition system. Appendix D discusses how the CO sensors were checked to verify the linearity of the output voltage versus the CO concentration. Figure 6 shows one of the CO sensors used in the generator tests.

---

<sup>4</sup> Model numbers; MBF6G - 004 (3MF/F), and MBE6O-014 (3ME/F) with 0.1 mV/ppm, and 1.0 mV/ppm output, respectively.



**Figure 6: Typical CO Sensor Positioned Around the Test Area**

The Model 2 CO alarms and the CO sensors were mounted on nine 1.8 m (6 ft) tall stanchions. Each stanchion supported two CO alarms and two CO sensors. A CO alarm/sensor pair was mounted above the base at approximately 1.07 m (3 ft 6 in) and at 1.68 m (5 ft 6 in). For identification purposes, each CO alarm and CO sensor was labeled as number 1 through 18. The even-numbered CO alarms were located at the highest point on the stanchion, while the odd-numbered alarms were located at the lower position on the stanchion.<sup>5</sup> One CO sensor on each stanchion was a low-range sensor (2,000 ppm) and the other sensor was a high-range CO sensor (20,000 ppm). On the nine stanchion, six low-range sensors and three high-range sensors were located at the highest position, while six high-range sensors and three low-range sensors were located at the lowest position.

In addition to using the CO alarms and CO sensors, staff used two types of portable handheld devices. The Mine Safety Appliance (Five-star®) portable gas analyzers were capable of measuring CO, oxygen (O<sub>2</sub>), temperature, and barometric pressure. An integral pump was used to draw gas samples to the electrochemical sensors. Rechargeable batteries provided approximately 10 to 13 hours of continuous operation, and the data could be saved to an internal memory. Accuracy for the Five-star® analyzer CO sensor is  $\pm 10$  percent, according to the manufacturer. However, staff found the accuracy to be better than 10 percent.

Staff also used the BW Technologies (Gas Probe IAQ) portable gas analyzers. These portable units were capable of measuring CO, temperature, and humidity. Instead of a pump, BW Technologies analyzers depend upon diffusion for sample transport to the electrochemical sensor. Rechargeable batteries provided approximately 10 to 13 hours of continuous operation, and the data could be saved to an internal memory. The accuracy of the Gas Probe IAQ CO sensor is  $\pm 3$  percent, and the accuracy of the temperature is  $\pm 0.2^\circ$  F, according to the manufacturer.

#### **2.4.2 M-Chamber Instrumentation**

The temperature inside the M-Chamber is measured with five thermocouples located near five gas sample locations. The air temperature inside the chamber was controlled through heat removal, which is accomplished by passing chilled water through two, 8.79 kW (30,000 Btu/hr) ceiling-mounted, fin-and-tube heat exchangers located in the chamber (Appendix A: Figure A6).<sup>6</sup> Two fans are used to control the air exchange rate of the chamber. The chamber can attain a maximum air exchange rate of approximately 30 air changes per hour (ACH). The chamber is instrumented to measure chamber concentrations of CO, carbon dioxide (CO<sub>2</sub>), oxygen (O<sub>2</sub>), and hydrocarbons (HC). A detailed description of the environmental chamber and its operating characteristics is contained in the CPSC staff document, “Medium-Sized Combustion Chamber System Characterization Tests” (Brown, 2004).

<sup>5</sup> The position of CO alarms 7/8 and 21/22 were reversed on the stanchion before the SSD tests were performed.

<sup>6</sup> Temperature not controlled for the four SSD test runs using the M-Chamber.

Gas samples in the M-Chamber are drawn from different locations using two independent sampling systems. Gas levels were measured using lab-grade, nondispersive infrared (NDIR) gas analyzers and lab-grade paramagnetic gas analyzers. One gas sampling system measured the concentration of CO, CO<sub>2</sub>, O<sub>2</sub>, and HC inside the chamber. Gas samples were obtained through five equal-length lines, from five different locations inside of the chamber and were blended using a gas-mixing manifold. The second sampling system measured the background concentration of CO in the laboratory. The sample lines conveyed gases, for both test sampling and calibration, to the analyzers at an approximate flow rate of 0.8 standard liters per minute (slpm) (1.7 ft.<sup>3</sup>/hr.) and at a pressure of less than 6.90 kPa (1 psi). Appendices A and B provide details of the equipment used in the M-Chamber.

## 2.5 Data Acquisition Systems

Staff used two independent computer-based data acquisition systems (DAS) to record the majority of test data. One DAS was associated with the M-Chamber and the other DAS was setup to record data from the sensors involved in the outdoor and TMS testing. Each DAS consisted of a computer running TESTPOINT™ data acquisition software. Typical data acquisition rates were preset by staff to be between 2 seconds to 5 minutes, depending on the rate of CO rise or fall, the air exchange rate, and the duration of the test.

The output from each of the CO sensors was recorded by the DAS during generator testing. The Five-star® and the Gas Probe IAQ handheld units were preset to record data to their internal memories every 15 seconds. Staff also used nine video cameras to view remotely the CO alarm LED lights (which indicated CO alarm activation) during testing in the TMS. The video cameras were connected to a monitor, video multiplexer, and digital video recording system. Results were viewed in real time on the monitor and recorded for follow-up review of the test data. The CO alarm's digital displays and activation times, load voltage and current, the differential pressure between the M-Chamber and laboratory (for chamber testing), and the temperature and relative humidity (not for chamber tests) were manually recorded.

# 3 TEST CONDITIONS, SCENARIOS & PROCEDURES

## 3.1 Test Conditions

Many factors can affect the amount of CO produced by the generator, such as the load on the generator, the air temperature, and the amount of oxygen available for combustion. The location of where the generator was tested determined what factors could be controlled during a test. When the generator was tested outdoors, only the load on the generator was controlled. When the generator was tested in the TMS, the load was controlled and the amount of oxygen available for combustion was controlled, to a certain extent. The amount of oxygen available in the TMS could be varied by altering the air exchange rate in the TMS. A tight building (low-ventilation rate) was simulated by closing the openings in the TMS (*e.g.*, windows, doors, and air vents), and a loose building (high-ventilation rate) was simulated by opening the various penetrations into the building. When the generator was tested in the M-Chamber, staff was able to control the load on the generator, the air temperature, and the oxygen available for combustion by varying the air exchange rate in the chamber. Each of these parameters (load, temperature, and air exchange rate) is discussed further below.

**Load:** The engine load affects the fuel consumption rate. In addition, all things being equal, the higher the load, the higher the CO generation rate. Full load, for test purposes, is defined as the maximum load the generator can sustain up to the rated load without tripping the generator's circuit breaker, which was determined in Phase 1 testing for Generator B to be 84 percent of the rated load. For all tests, staff ran the generator with no load for approximately 10 minutes to 20 minutes, followed by full loading for the remainder of the test.

**Temperature:** When testing outdoors and in the TMS, staff ran the generator under ambient test conditions. Average temperatures during M-Chamber tests ranged from 25°C to 33°C (77°F to 91°F). Average temperatures during outdoor testing and in the TMS ranged from 17°C to 35°C (62°F to 95°F). The temperature was measured prior to each test and continuously during testing at three locations, with at least two locations being near the generator.

**Air Exchange Rate:** The air exchange rate (AER) is the rate at which indoor air is exchanged with the outdoor air. Typically, the AER may be expressed in terms of air changes per hour (ACH). For example, an AER of 0.5 ACH means that the volume of air passing through the chamber in an hour is equal to  $0.5 \times$  chamber volume. The air exchange rate affects the oxygen available for combustion. A gas-fired product will typically increase production of CO when it is operating in a room that is being depleted of oxygen. Staff conducted testing on Generator B in the M-Chamber with an air exchange rate of approximately 29 ACH. The ACH was uncontrolled during all other testing, but was changed by opening or closing vents and doors when testing in the TMS. The CO decay, from which the ACH is calculated, was measured when staff tested in the TMS.

### 3.2 Test Scenarios

Table 2 identifies 29 tests conducted by CPSC staff. In general, the generator was tested at six different locations, with and without the safety shutoff device. The exception to this was when the generator was tested under the TMS (Test 5a).

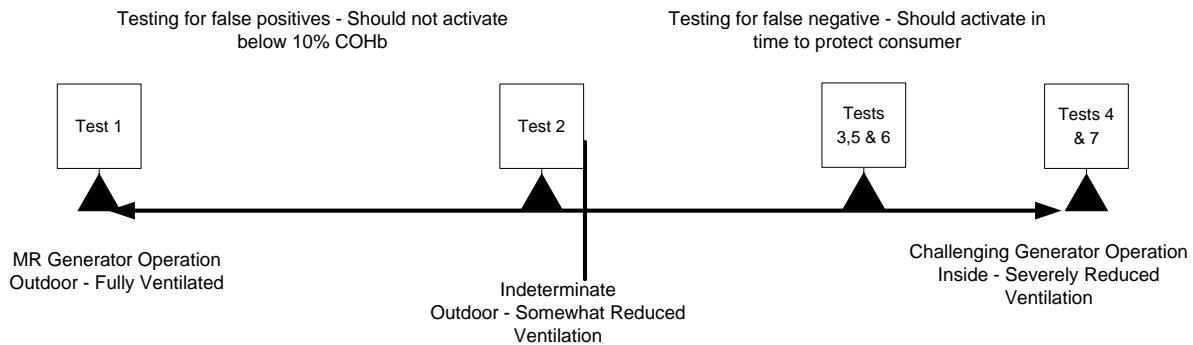
**Table 2: Generator Tests**

| Test ID No. | Generator Location  | Tests Without the SSD (“a” series) | Tests with the SSD (“b” series) |
|-------------|---|------------------------------------|---------------------------------|
| 1a/1b       | Outdoor parking area (courtyard)  | 4                                  | 1                               |
| 2a/2b       | Under two-sided roof shelter - (exhaust to wall, exhaust to parking area) | 4                                  | 2                               |
| 3a/3b       | Inside TMS building (large roll-up door open)                             | 4                                  | 2                               |
| 4a/4b       | Inside TMS building (all doors closed; vents open or vents closed)        | 3                                  | 2                               |
| 5a          | Underneath TMS in crawlspace (roll-up door open to several heights)       | 1                                  | 0                               |
| 6a/6b       | Underneath TMS in crawlspace (TMS vents closed/doors closed)              | 1                                  | 1                               |
| 7a/7b       | Inside M-Chamber (well mixed area)  | 0                                  | 4                               |
|             | <b>Total</b>  | <b>17</b>                          | <b>12</b>                       |

Figure 7 portrays the range of Table 2 testing scenarios in terms of test area ventilation. Some tests conducted were consistent with the manufacturer’s instructions for Generator B operation<sup>7</sup>

<sup>7</sup> Manufacturer’s manual states there should be at least 2 ft of clearance around the generator, to run the generator outdoors where adequate ventilation is available and do not run in enclosed area, even if doors and windows are

(Manufacture Recommended Operation, or MR Generator Operation). Some other tests were conducted that were more consistent with incident data scenarios, but were inconsistent with the manufacturer’s suggested operation (Challenging Generator Operation). In addition, staff established Test 2 (operating under a two-sided shelter) to evaluate operating conditions in a partially ventilated area, such as on a porch or under an awning. This portrayal of the test scenarios was used to evaluate possible nuisance alarms (false positives) and situations where a CO alarm should activate.



**Figure 7: Comparison of the Severity of Generator Tests**

### 3.3 Pre-Test Setup

At the start of each day, staff calibrated each lab-grade gas analyzer involved in the day’s tests, according to the manufacturer’s instructions. In general, the gas analyzers were zeroed with nitrogen gas or room air and then spanned (partial calibration) using a certified calibration gas of known concentration. The O<sub>2</sub> analyzers were spanned using room air and/or a certified standard.

For the outdoor tests, staff recorded the wind direction and classified the wind in general terms (*e.g.*, calm, windy). Staff also recorded the barometric pressure, outdoor and/or lab temperature, and initial “ambient” CO concentration in the test areas.

The load bank cables and the remote safety cut-off switch wires were connected to the generator. Additionally, video camera wires, sensor wires, and/or the SSDs were connected, if they were intended for the test.

Staff fueled the generator with locally purchased 87 octane gasoline and added 5W-30 oil to the oil reservoir, per the manufacturer’s instructions, as needed. The generator’s oil was changed before the first test, after the break-in period, and every 25 to 50 hours, as recommended by the manufacturer.

Four CO alarms were mounted to the generator.<sup>8</sup> In addition, portable gas analyzers monitored the gas concentrations near three of the four generator-mounted CO alarms. Staff alternated two sets of three portable analyzers, as testing required. When testing outdoors or in the TMS, the nine stanchions were placed at various locations around the test location. In all tests, the CO alarms were involved. The

open.

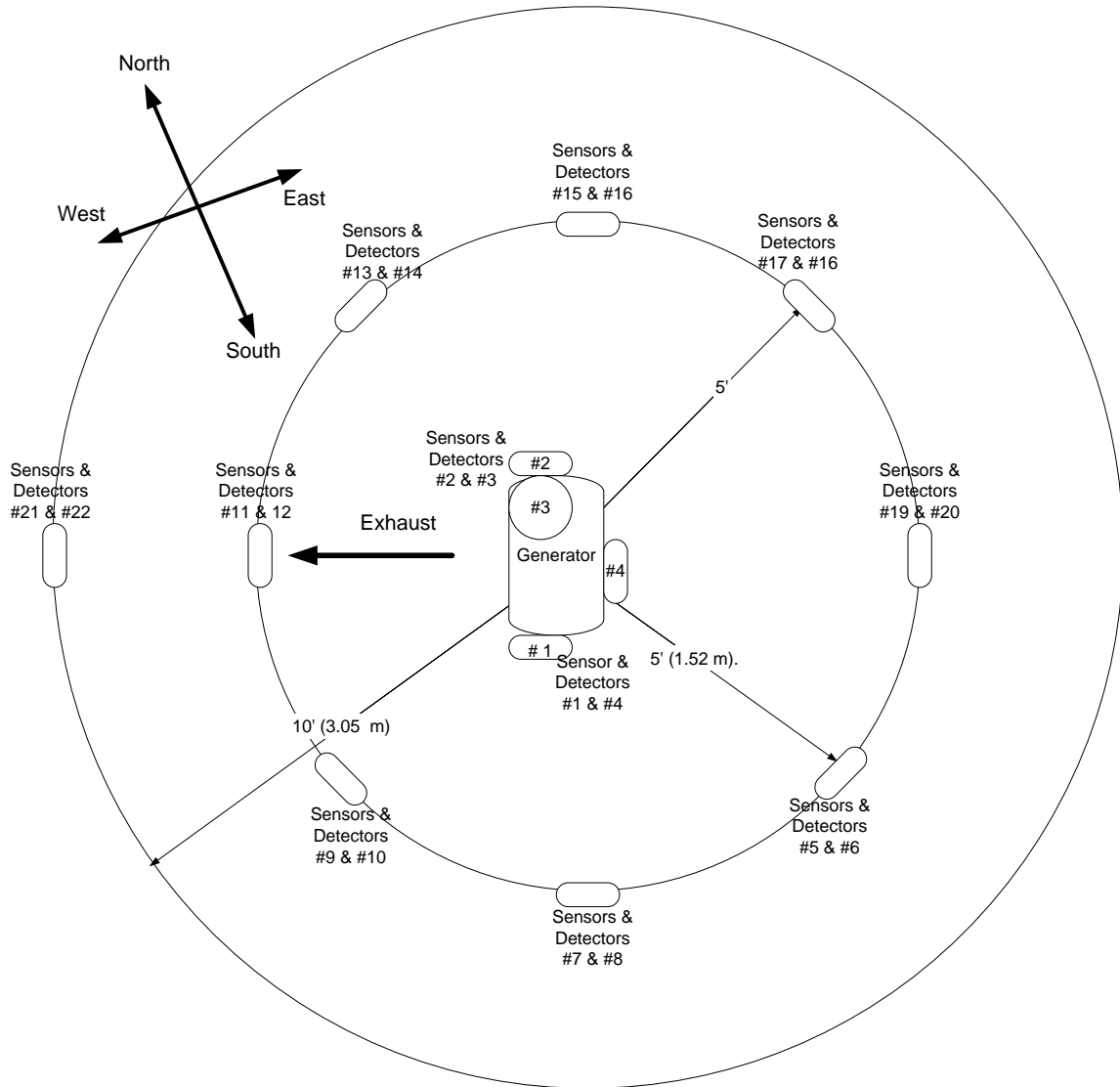
<sup>8</sup> Three of the four Model 2 CO alarms (Numbers 1, 2 and 4) that were initially placed on the generator were exchanged with those incorporated into the SSD (Model 1 CO alarms), when the SSD was installed.



CO sensors were added to the tests setup after completing the initial outdoor tests, and prior to the TMS testing (for Tests 3a.1 through 6b.1).

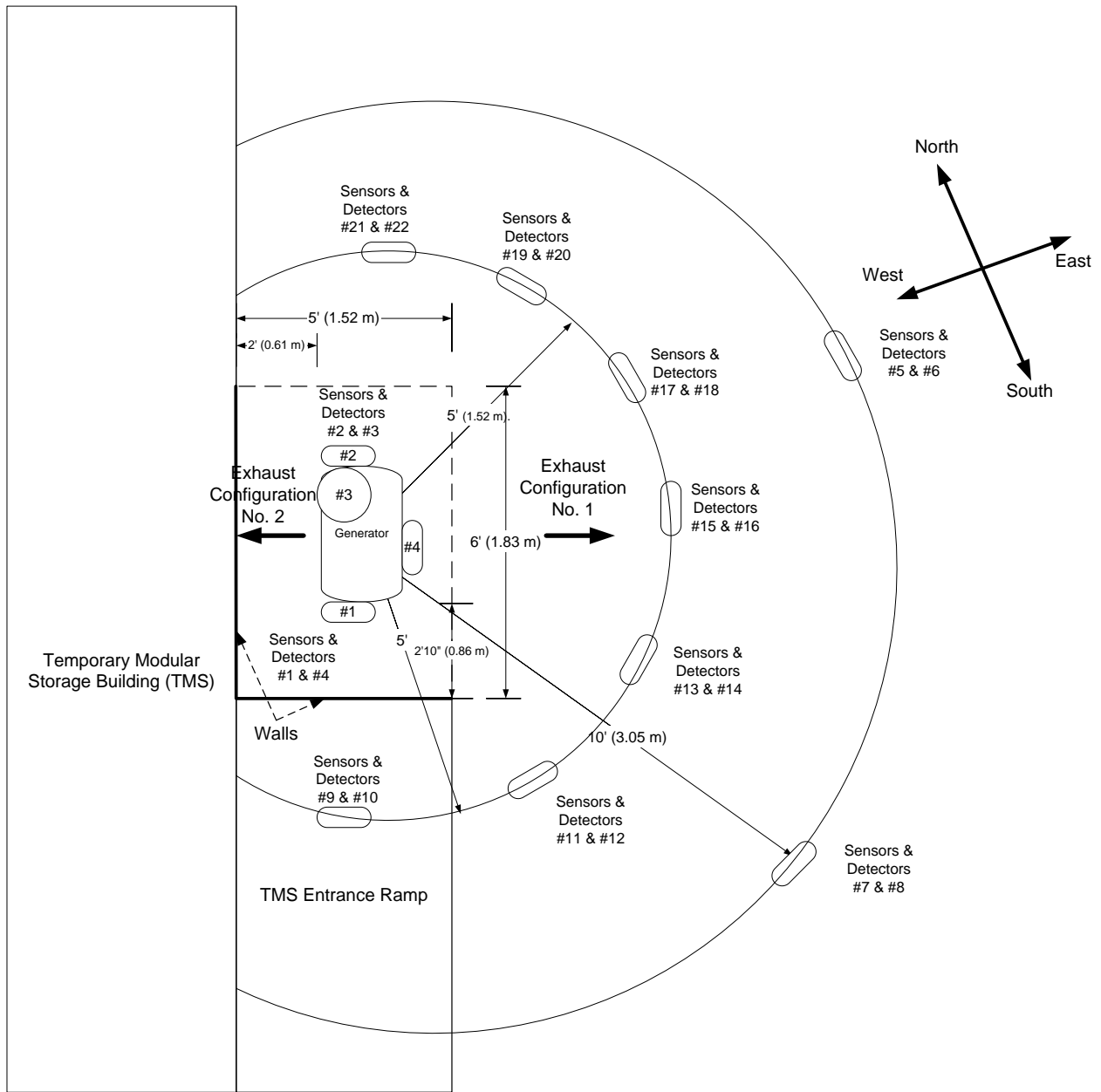
### 3.3.1 Outdoor Tests

The generator was positioned in the configurations shown in Figures 8 and 9, when testing in the center of the courtyard area or underneath the two-sided roofed shelter, respectively. The exhaust was directed as shown in the figures.



**Figure 8: Plan View: Setup for Outdoor Tests Conducted in Center of Parking Area**

As shown in Figure 9, the generator was tested with the exhaust pointing away from the wall of the two-sided roofed structure in one test and toward one wall of the two-sided structure in a different test



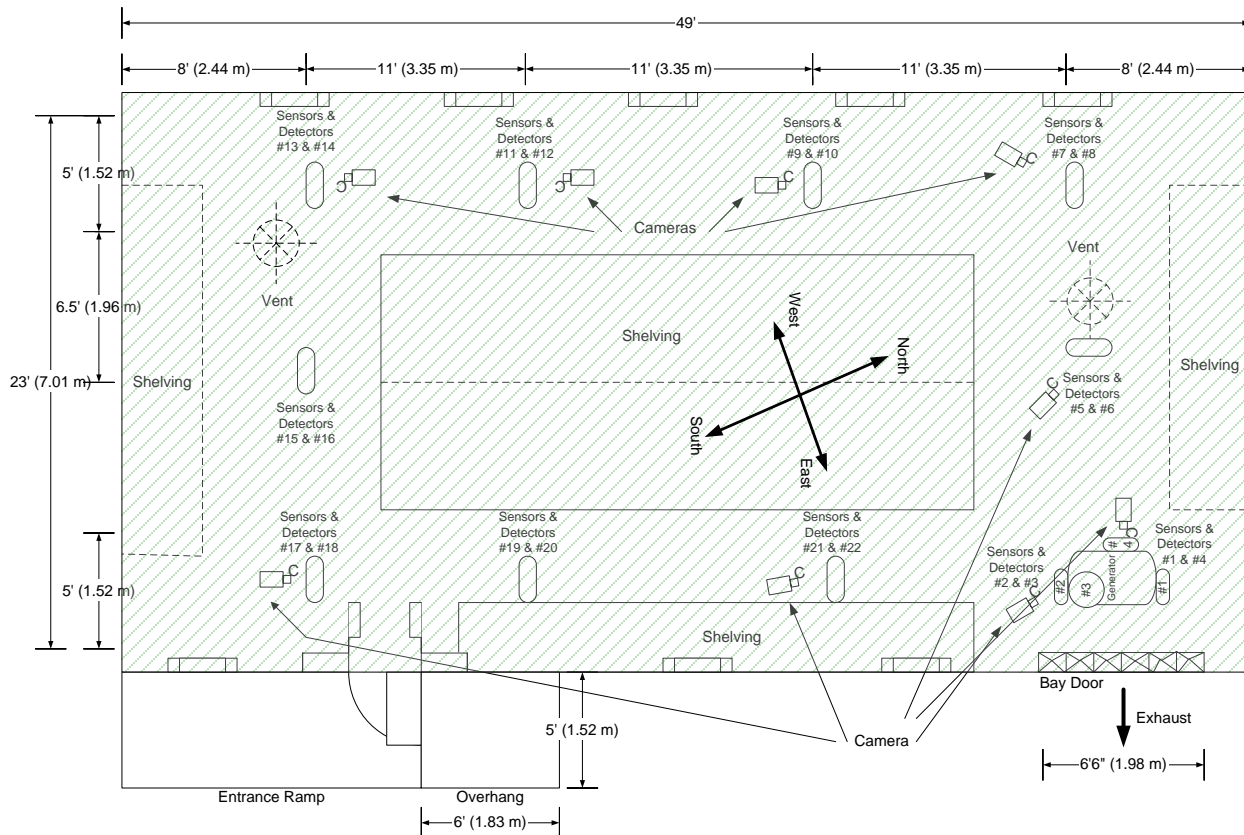
**Figure 9: Plan View: Setup for Outdoor Tests Conducted under Two-Sided Roofed Shelter beside TMS.**

Sensors and CO alarms 9 and 10 sat on an elevated (0.84 m/2 ft 9 in) entrance ramp in front of a TMS door.

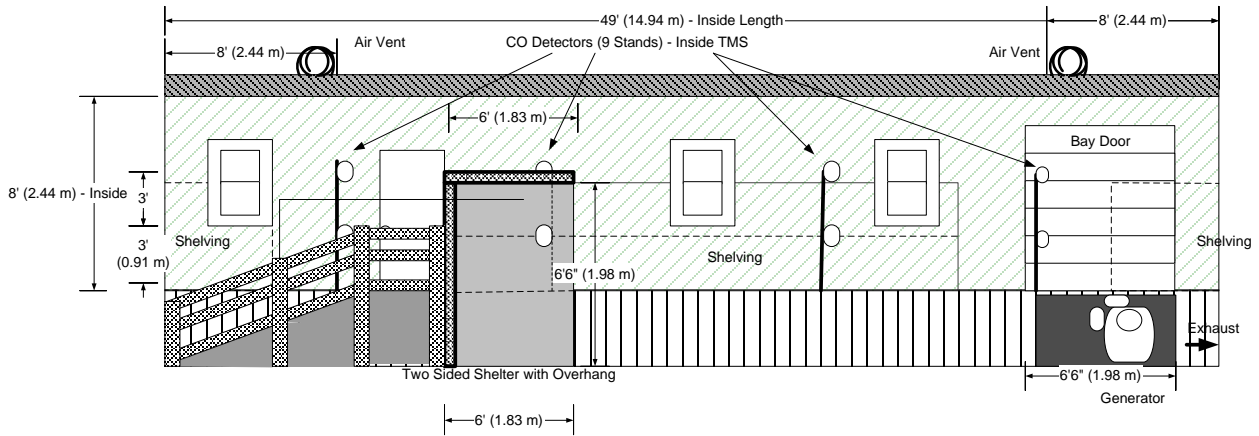
### 3.3.2 TMS Tests

When testing inside the TMS or under the TMS, the test generator was placed as shown in Figures 10 and 11, respectively. When the generator was located inside the TMS, the exhaust was directed toward the roll-up (bay) door or out of the building through the open doorway. When the generator was located under the TMS, the exhaust was directed under the TMS toward the northern corner of the building. The roll-up door and the two roof air vents were either opened or closed as each test required.

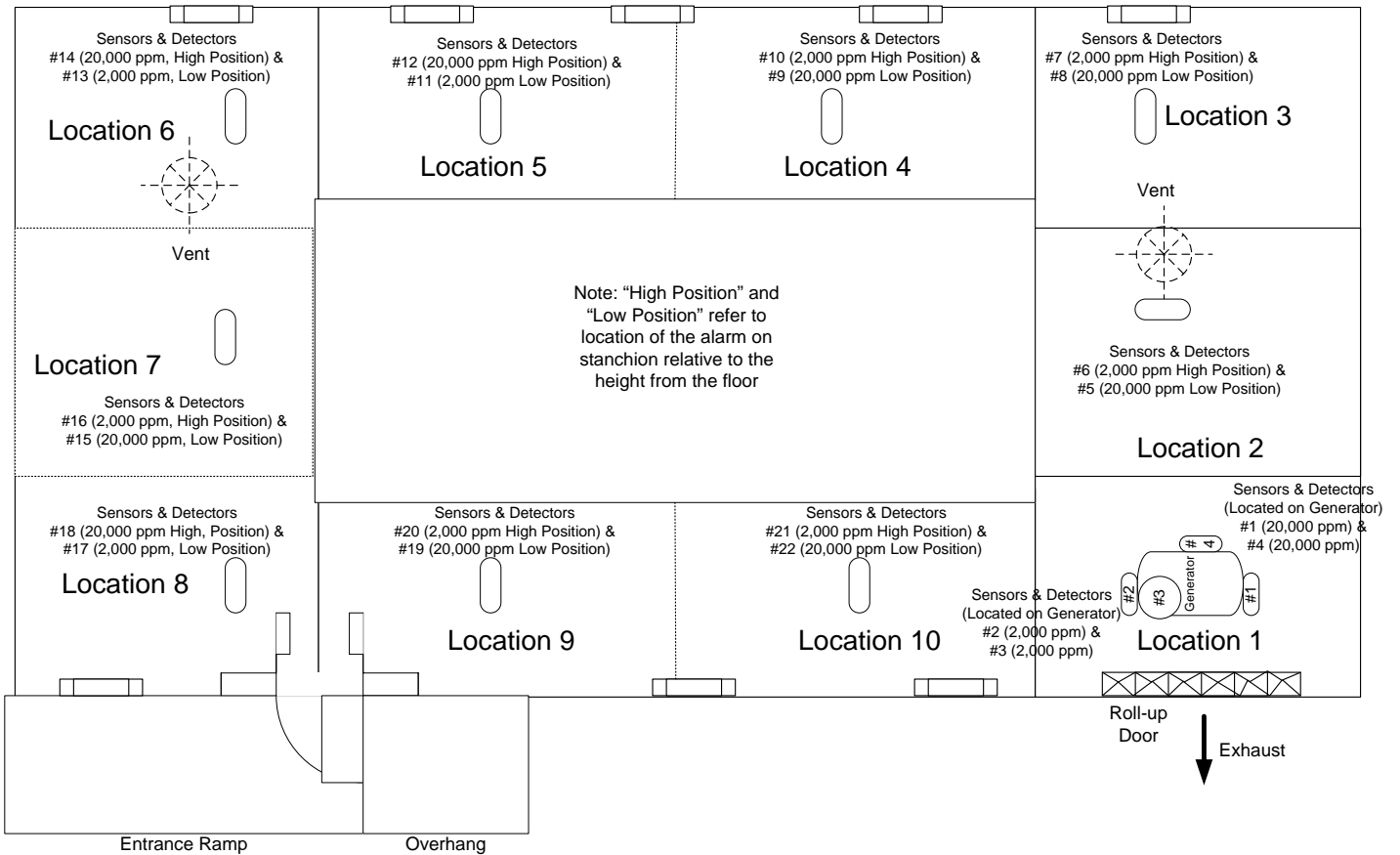
The nine video cameras were positioned to view remotely the CO alarm displays for CO alarm numbers 2, 4, 5, 8, 9, 11, 13 or 14, 18, and 22. The CO alarm activity for the nine cameras was viewed simultaneously, in real-time, on a 15-inch monitor and recorded.



**Figure 10: Plan View: Setup for Tests Conducted Inside TMS**



**Figure 11: Elevation View: Setup for Tests Conducted Under TMS in Crawlspace**



**Figure 12: Plan View Inside TMS: Legend Showing Location of CO Sensors and CO Alarms and Where AER Calculations Were Performed**

### **3.3.3 M-Chamber Test**

Staff placed the generator near the center of the M-Chamber with the exhaust directed away from the door. The ventilation rate of the chamber was set by first, fully opening the exhaust air pipe and the supply air pipe, and then adjusting the manually operated irises, which were located in each pipe. Next, the exhaust fan's voltage was adjusted to achieve the desired ACH. Finally, the supply fan's voltage was adjusted until the desired differential pressure (approximately 0.25 inches water column (w.c.) vacuum relative to outside the chamber) was achieved. The differential pressure of the chamber remained relatively constant during each test. After setting the chamber ventilation rate, staff started the data acquisition program. The ambient temperature was not controlled during testing.

### **3.4 Test Procedures for Generator Operation**

Staff placed the generator in one of the locations listed in Table 2, and with the generator and sensors placed in one of the configurations shown in Figures 8, 9, 10, 11, or in the M-Chamber. All appropriate pretest preparations were made. The generator was then manually started. For testing in the TMS, the door was either closed or left in an open position depending on the test scenario. In general, the generator was operated with no load for at least 10 minutes. After operating the generator with no load, the generator was operated at 100 percent (full load) of the maximum sustainable load. Electrical loading was performed with an adjustable resistive load bank located adjacent to the M-chamber. The generator was loaded using the 240-volt output. Protocol dictated that each test would be run until one or more of the following occurred (with exception as circumstances dictated):

- 1) up to 6 hours had elapsed (outdoor tests),
- 2) approximately 1 hour had elapsed (TMS tests),
- 3) the CO concentrations appeared to approach equilibrium (TMS tests),
- 4) the SSD shut off the generator, or
- 5) the ambient CO concentration reached 25 ppm in the laboratory (M-Chamber tests).

At the end of the test, staff removed the electrical load, and the generator was shut off using a remote toggle switch that paralleled the existing generator shut-off system, if the SSD had not activated. The CO concentrations were recorded prior to the generator's operation and through a portion of the CO decay after generator shutdown. After enough decay data were collected, the TMS was ventilated using two floor fans or the M-Chamber was ventilated using the chamber's exhaust fans. After the test was completed, the test data were downloaded to a personal computer from the portable analyzers. The humidity and temperature were recorded, both manually and logged by the portable analyzers. In addition, the generator output voltage, current, and engine oil sump temperature were recorded manually. Peak readings from the CO alarms were recorded, and all the CO alarms were reset (cleared of all previous CO readings), prior to performing the next test.

### **3.5 Air Exchange Rate Test**

Tracer gas decay is a standard method for characterizing the number of air changes per hour (ACH) in a room or building. A tracer gas, such as CO or SF<sub>6</sub>, is injected into the test area and is allowed to decay. Staff measured the ACH of the TMS or M-Chamber during a test, using CO and recorded the decay of the gas concentration by computer and, staff manually recorded the data as well. A decay test was considered complete once the CO concentration was less than approximately 10 times the maximum background CO concentration and greater than 2 percent of the gas analyzer's full-scale value, or at least after 20 minutes had passed since the start of the decay. After the decay, the test area was ventilated completely before beginning the next test.

## 4 DATA ANALYSIS

This section describes how the raw data collected during the tests were reduced into useful information. Appendix E of the Phase 1 test report (Brown, 2006) provides detailed derivations of the equations listed below.

### 4.1 CO Alarms and Sensor Data

When testing outdoors, staff directly observed and recorded the CO alarm activation states. When testing in the TMS with the doors closed, staff used video cameras and a remote monitor to observe the display and activation of up to nine of the 22 alarms.

When testing with the SSD operational, the shut down of the generator alerted staff to the activation of any of the alarms incorporated into the SSD. The specific alarm that activated was not always apparent from the digital display and (for safety reasons) staff often could not enter the area surrounding the generator for some time after the test.

The peak CO concentration for each CO alarm was recalled and manually recorded after each test, with a few exceptions. Occasionally the number of CO alarms included in tests varied, causing variations in the number of CO alarm readings taken during tests. Sometimes this was due to alarm failure; sometimes it was due to safety concerns or other considerations. Variations in the number of CO sensors available for a test were primarily due to CO sensor malfunction<sup>9</sup> and/or a change in the test requirements.

Staff collected and graphed CO sensor data to show the magnitude and the distribution of CO concentrations in the test area. However, for clarity, data from a limited number of sensors are displayed on each graph. Graphs for additional tests are displayed in Appendix C. Generally, only the sensors that best resolve the data are shown. If CO concentrations were below 2,000 ppm, only data from the low range sensors are graphed; and if CO concentrations were above 2,000 ppm, only data from the high range sensors are graphed. Due to excessive noise, some real-time data for Sensor 2 were replaced with a 2-minute moving average (two charts only). Generally, no more than 2 minutes of consecutive data were removed.

Staff rounded data below 1,000 ppm to the nearest 50 or 100 and used two significant figures for data above 1,000 ppm.

### 4.2 Air Exchange Rate Data Analysis

The air exchange rate (expressed in terms of air changes per hour) for the M-Chamber and the TMS was calculated from the decay of the CO (for these tests CO was the tracer gas). However, the TMS environment was not well mixed, which is normally required for ACH measurements.<sup>10</sup> The M-Chamber was well mixed. Using a simple mass balance of the tracer gas in the room, the decay of the tracer gas with time can be described by Equation 1. In deriving Equation 1, the following assumptions are made: (a) the tracer gas in the room is well mixed; (b) the tracer gas does not get absorbed inside the room; and (c) the background concentration of the tracer gas is zero.

$$C = C_0 e^{-kt} \quad [1]$$

---

<sup>9</sup> During the first 2 days of testing, seven of 11 sensors of each type were available. Later, 10 to 11 sensors were available, but some sensors demonstrated excessive noise or bias. See Appendix C to view charts.

<sup>10</sup> ACH calculations for the TMS are not intended to reflect the actual ACH, but they show the variability of ventilation throughout the TMS and over time.

In Equation 1,  $C$  is the concentration of the tracer gas at time  $t$ ,  $C_0$  is the initial concentration of the tracer gas at the start of the decay,  $k$  is the air exchange rate, and  $t$  is time. Equation 1 can be rearranged to solve for the quantity ( $kt$ ) as follows:

$$\ln \frac{C}{C_0} = -kt \quad [2]$$

Equation 2 indicates that a plot of the quantity  $\ln (C/C_0)$  versus time should be linear and that the air exchange rate ( $k$ ) will be equal to the slope of this line. For many tests, a linear regression was performed on the tracer gas decay data and the air exchange rate was obtained from the slope of this line. Otherwise, the air exchange rates were obtained through a direct application of Equation 2 to the test data.

Table 3 shows the time it takes for CO concentrations to decrease by half of their starting value (*i.e.*, half-life value) at various air exchange rates and is provided for reference. The calculated values are based on solving for the time value ( $t$ ) in Equation 2, assuming a  $C/C_0$  value of 0.5. These calculated data may be applied to chart data presented in the results section for a better understanding of the decay process inside the TMS. As Equation 2 illustrates, this calculation is independent of the room size.

**Table 3: Half-life for CO Concentration Inside a Room at Various ACHs**

| <b>ACH<br/>(air changes per hour)</b> | <b>Half-Life<br/>(hours)</b> | <b>Half-Life<br/>(minutes)</b> |
|---------------------------------------|------------------------------|--------------------------------|
| 0.25                                  | 2.77                         | 166                            |
| 0.50                                  | 1.39                         | 83                             |
| 0.69                                  | 1.00                         | 60                             |
| 1                                     | 0.69                         | 42                             |
| 2                                     | 0.35                         | 21                             |
| 3                                     | 0.23                         | 14                             |

## 5 GENERATOR TEST RESULTS

This section summarizes the results of the 29 Phase II tests that were performed between July and November 2005. Staff conducted a total of 17 tests prior to the SSD being installed: eight outdoors and nine inside or under the TMS. After the SSD was installed, 12 tests were performed: three outdoors, five inside or under the TMS, and four in the M-Chamber. The testing was performed without attempting to control the ambient temperature. Tests were not performed outdoors or under the TMS in the rain, or in the TMS during heavy rains.

### 5.1 Pre-SSD Tests

#### 5.1.1 Outdoor Tests (1a and 2a)

During outdoor testing, average temperatures (recorded by the portable analyzers) near the generator ranged from 29°C to 35°C (84°F to 95°F). Note that the average temperature near the generator depended on ambient conditions, the proximity of the measuring equipment to the generator, and the location of the generator. Analyzers in the direct path of the exhaust (due to wind direction) recorded higher averages and maximums. The lowest reported averages come from the portable analyzer that was sometimes located several feet away from the generator<sup>11</sup> and not in the direct path of the exhaust. However, even this value may be several degrees higher than the ambient average temperature away from the generator. The maximum temperature recorded near the generator by the portable devices was 53°C (129°F). The tests were performed in July and August 2005.

The percentage of CO alarms activating during the outdoor tests ranged from 9 percent to 50 percent. Because the tests were performed outdoors, results were affected by the weather conditions. Wind conditions were observed, but they were not measured quantitatively. Generally, the wind velocity for most tests could be described as a light breeze. However, there were occasional periods that included wind gusts. The alarms that activated were all located within 1.5 m (5 ft) of the generator.

For the four courtyard tests, staff operated the generator between 3 hours 20 minutes and 4 hours 30 minutes. Generally, the activating alarms were located within a 135-degree arc centered on the generator exhaust. As shown in Table 4, peak CO concentrations recorded by the alarms reached and likely exceeded the range of the alarms (999 = maximum reading) during several tests. The CO alarms are listed in the order of activation in Table 4. The earliest CO alarm activation, when testing in the courtyard, occurred 19 minutes after the generator started. During one test, the first CO alarm activation occurred more than 1 hour after the generator was started. This illustrates the effect natural ventilation (air velocity, air temperature, and direction) can have on CO concentrations in an open area.

When the generator was placed in the two-sided roofed shelter beside the TMS with the exhaust directed away from the TMS, the activating alarms were located within approximately a 150-degree arc centered on the generator exhaust. When the exhaust was directed toward the TMS, one to two alarms located on the generator activated, as well as two alarms directly opposite of the direction of the exhaust. Apparently, the exhaust deflected off the TMS wall and flowed in the opposite direction back toward the generator to activate these units.

---

<sup>11</sup> One portable analyzer was located away from the generator during tests performed under the two-sided roofed shelter.



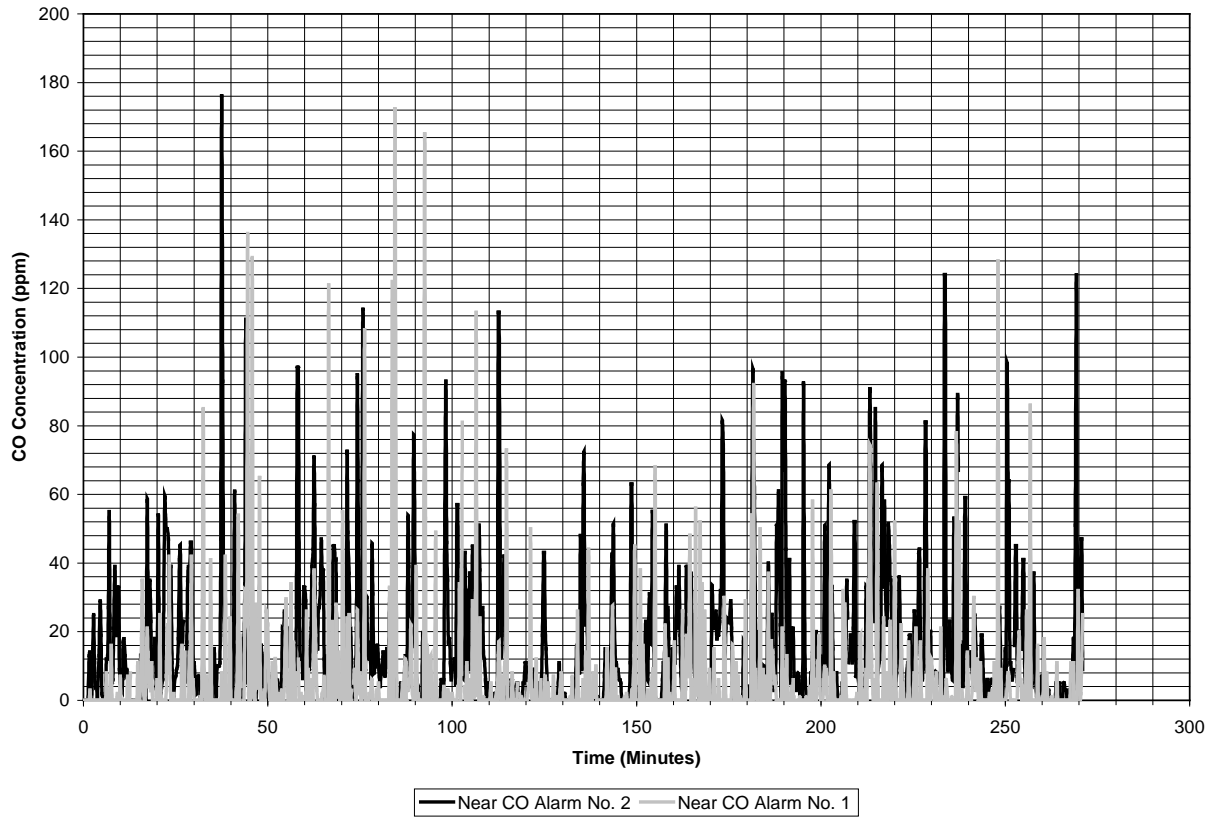
**Table 4: Outdoor Pre-SSD Tests: CO Alarm Summary**

| Test ID No. | Description   | CO Alarm activations | Alarm ID Numbers (See Figures 8 and 9)         | Time of First Activation from Start of Test (hr:min) | Range of Peak Reading of All Alarms (ppm) |
|-------------|---|----------------------|--|--|---|
| 1a.1        | Courtyard   | 5 of 20              | 11, 13, 14, 9, 7                               | 00:24  | 181 - 794 <sup>1</sup>                    |
| 1a.2        | Courtyard (repeat of test 1a.1)   | 3 of 20              | 11, 9, 12                                      | 00:19  | 37 - 999                                  |
| 1a.3        | Courtyard (repeat of test 1a.1)   | 4 of 22              | 11, 9, 12 & 13                                 | 00:24  | 37 - 950                                  |
| 1a.4        | Courtyard (repeat of test 1a.1)   | 2 of 22              | 11, 9  | 1:02   | 45 - 833                                  |
| 2a.1        | Two-Sided Roofed Shelter -Exhaust Away From TMS                                 | 6 of 22              | 13, 14 & 15, 16, 11, 12                        | 00:31  | 52 - 999                                  |
| 2a.2        | Two-Sided Roofed Shelter - Exhaust Away From TMS (repeat of test 2a.1)          | 11 of 22             | 13 & 15, 14, 16, 18, 20, 12, 17 & 19 & 21 & 22 | 00:19  | 70 - 999                                  |
| 2a.3        | Two-Sided Roofed Shelter- Exhaust Toward TMS <sup>2</sup>                       | 3 of 21              | 2, 14 & 16                                     | 00:29  | 71 - 678                                  |
| 2a.4        | Two-Sided Roofed Shelter- Exhaust Toward TMS <sup>2</sup> (repeat of test 2a.3) | 4 of 22              | 2, 14, 16, 1                                   | 00:48  | 72 - 435                                  |

<sup>1</sup> Peak CO concentrations may actually be higher, but peak readings were obtained from CO alarms during the tests but not at the end of the test.

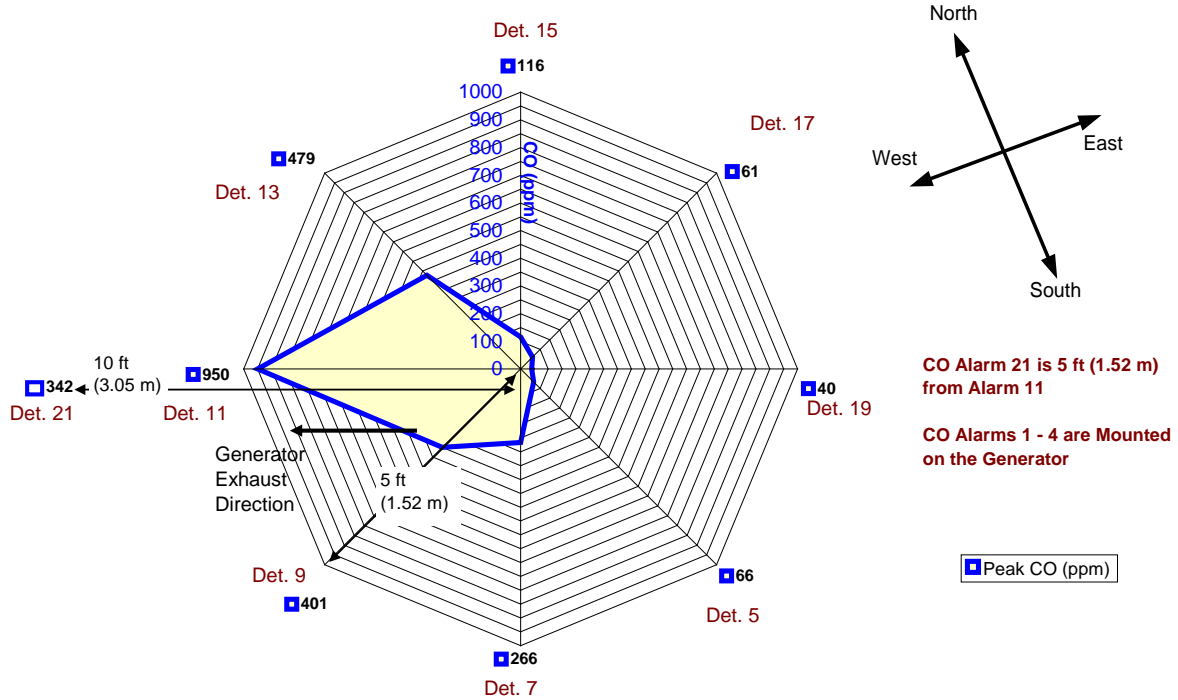
<sup>2</sup> CO alarms on the generator were the first to activate.

Figure 13 presents data from two portable analyzers located on opposite sides of the generator. The patterns are typical of how CO concentrations vary significantly in close proximity to the generator when operating in the open area of the courtyard under a light breeze condition. Maximum CO concentrations around the generator for this test were much higher at distances of 1.5 m (5 ft) (950 ppm) and 3.0 m (10 ft) (375 ppm did not alarm during test), as shown by the CO alarm peak readings and CO alarm activations in Table 4.

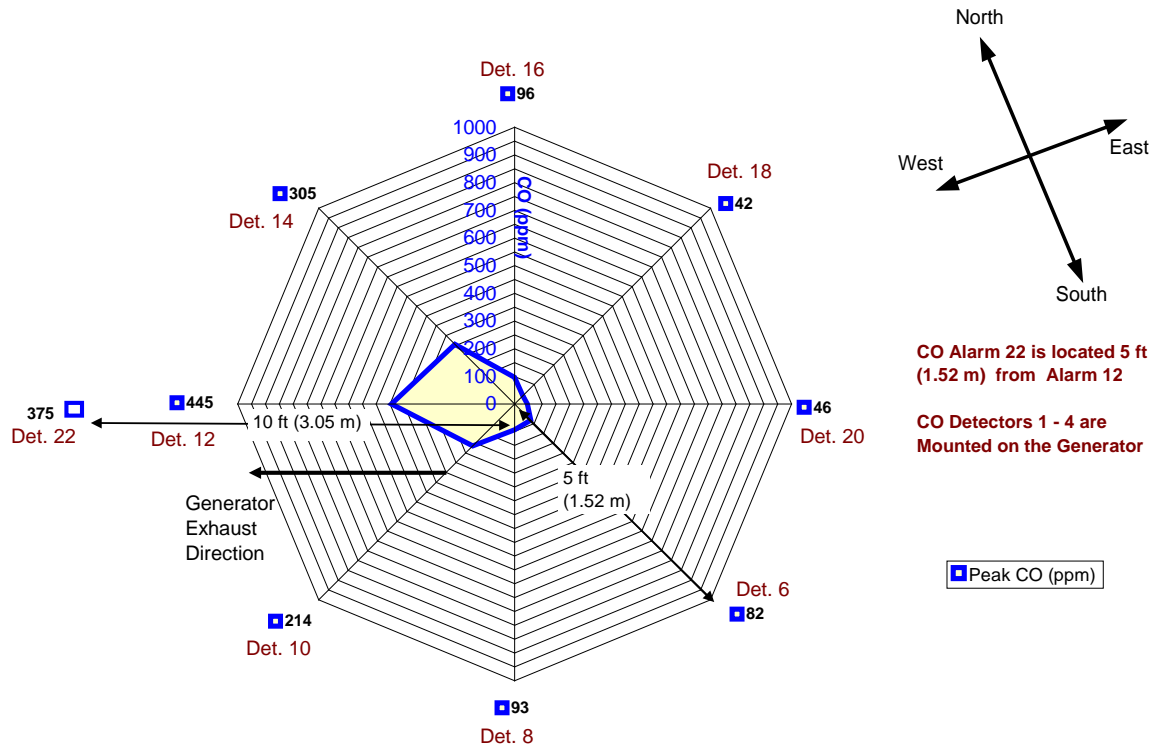


**Figure 13: Test 1a.3, CO Concentrations on Two Sides at a Distance of Approximately 7.6 to 15.2 cm (3 to 6 Inches) from the Generator, 7/19/05, Tested in the Middle of Courtyard.**

Figures 14 and 15 show the CO alarm peak reading pattern at heights of approximately 1.07 m (3 ft 6 in) and 1.68 m (5 ft 6 in), respectively. Notice that the highest peak levels come from CO alarms positioned directly opposite the exhaust pipe of the generator. The generator was located at a position represented by the center of the radar chart.



**Figure 14: Test 1a.3, CO Alarm Peak Readings at a Height of 1.07 m (3 ft 6 in) Above the Ground Around the Generator, 7/19/05, Tested in the Middle of the Courtyard**



**Figure 15: Test 1a.3, CO Alarm Peak Readings at a Height of 1.68 m (5 ft 6 in) Above the Ground Around the Generator, 7/19/05, Tested in the Middle of the Courtyard**

### 5.1.2 Indoor (TMS) Tests (3a, 4a, and 5a)

For the first two tests in the TMS, staff used 14 operational CO sensors and 7 video cameras. For subsequent tests, the number of sensors and cameras was increased to 22 and 9, respectively. The nine cameras were positioned to view remotely CO alarm displays for CO alarm numbers 2, 4, 5, 8, 9, 11, 13 or 14, 18, and 22. Figures 10 and 11 show the test setups. CO sensors, CO alarms and the portable gas analyzers measured gas concentrations inside the TMS building. One double-hung window was open approximately 1.3 cm (0.5 in) to allow power lines into the building. Sensor wires entered through a gap under one door. Large air fans were used to clear the TMS of CO after testing. During testing, temperatures near the generator in the TMS ranged from approximately 21° C to 34° C (69° F to 93° F), as measured by the portable gas analyzers. The tests were performed in October and early November 2005.

Generally, all the monitored CO alarms located in the TMS alarmed during testing in the TMS. Table 5 lists the CO alarms that activated, and the peak CO concentrations recorded by the CO alarms. CO alarms tended to stop sounding soon after CO cleared from the building, except when CO concentrations had reached 999 ppm.<sup>12</sup> Then, the CO alarms would keep sounding for several minutes after the CO concentrations in the building had dropped to below approximately 30 ppm. Some CO alarms that were not viewable when conducting closed door tests, and were not monitored with a camera, were observed through the open door during some tests. During tests where the roll-up door was open,

<sup>12</sup> Represents the maximum reading that can be recalled from CO alarm memory, or displayed on the alarm LED.

staff could sometimes determine through direct visual observation of the alarm LED when CO alarms mounted on the generator activated, in addition to those monitored with the cameras. Staff also knew from experience that when the peak CO concentration recorded by the alarms was above 999 ppm, the CO alarms had activated.

**Table 5: TMS Pre-SSD Tests: CO Alarm Summary**

| Test ID No. | Description   | CO Alarm Activations | Alarm Numbers (See Figures 10 and 11)  | Time of First Activation from Start of Test (hr:min) | Range of Peak Reading of Activating CO Alarms (ppm) |
|-------------|---|----------------------|--|--|---|
| 3a.1        | In TMS, Vents Open, Roll-Up Door Open                         | 9 of 9               | 1, 8, followed by 2 & 4 & 13 & 18 & 11 & 8 & 22 together <sup>2</sup>        | 00:30  | 220 - 341   |
| 3a.2        | In TMS, Vents Open, Roll-Up Door Open (repeat of test 3a.1)   | 10 of 10             | 1, 8, 13 & 5 together, 2, 4, 18, 11, 22, 9 <sup>2</sup>                      | 00:34  | 236- 327  |
| 3a.3        | In TMS, Vents Closed, Roll-Up Door Open                       | 9 of 9               | 13 & 18, 2 & 8 & 9 & 11 & 22 together, 4 & 5 <sup>2</sup>                    | 00:20  | 223 - 303   |
| 3a.4        | In TMS, Vents Closed, Roll-Up Door Open (repeat of test 3a.3) | 9 of 9               | 14 <sup>1</sup> , 2 & 5 & 9 & 11 & 13 & 18 & 22 together, 4 <sup>2</sup>     | 00:39  | 291 - 373   |
| 4a.1        | In TMS, Vents Open, Roll-Up Door Closed                       | 22 of 22             | 5, 2 & 9, 1 & 4 & 11 & 13 & 18 & 22 together <sup>2</sup>                    | 00:15  | 999 - 999   |
| 4a.2        | In TMS, Vents Open, Roll-Up Door Closed (repeat of test 4a.1) | 22 of 22             | 2, 4, 5, 8, 9, 11, 13, 18, 22 all activated very close together <sup>2</sup> | 00:14  | 999 - 999   |
| 4a.3        | In TMS, Vents Closed, Roll-Up Door Closed                     | 22 of 22             | 9, 2 & 4 & 5 & 8 & 11 & 13 & 18 & 22 together <sup>2</sup>                   | 00:13  | 999 - 999   |
| 5a.1/6a.1   | Under TMS, Vents Closed, Roll-Up Door Closed then Open        | 3 of 22              | 1,2, and 3, order not discernable <sup>2</sup>                               | 00:30  | 24 - 999  |

<sup>1</sup> Camera moved from CO alarm 13 to 14. Last indoor test before SSD tests.

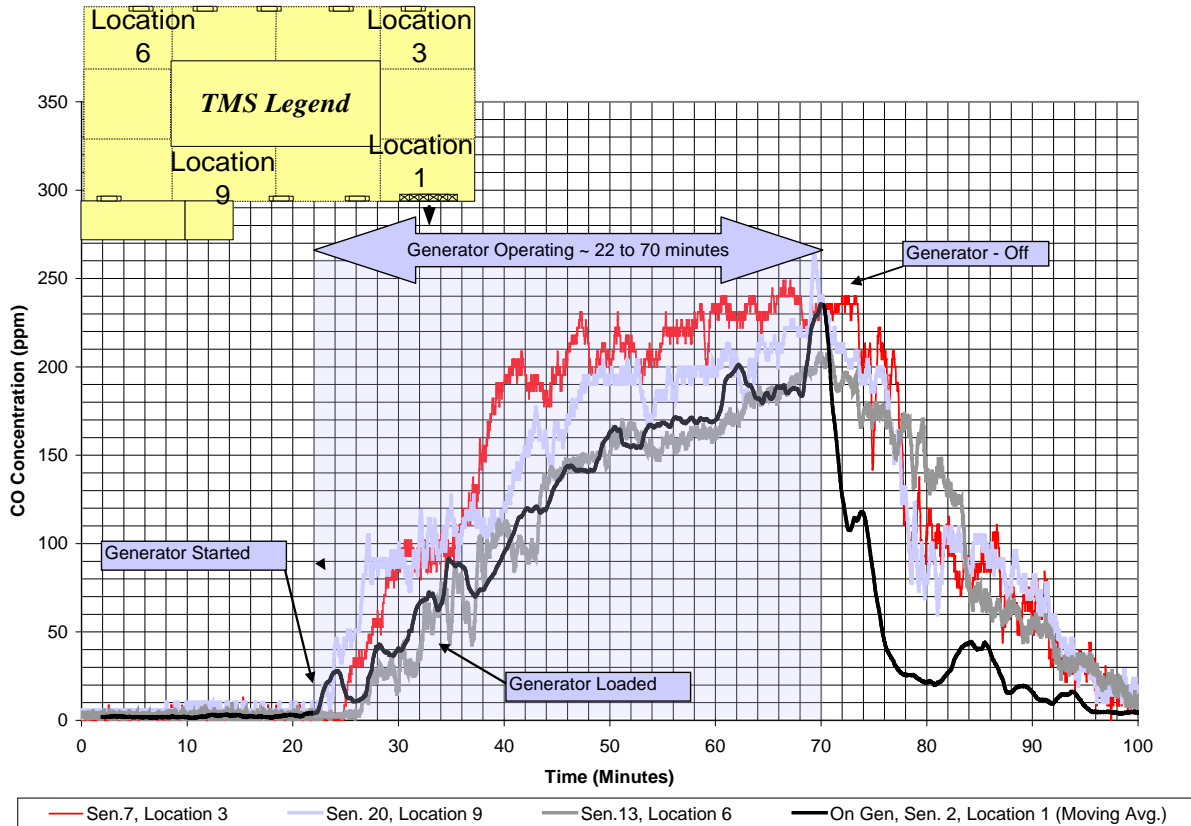
<sup>2</sup> The occurrence of alarm activation and/or time of activation of remaining detectors not discernable due to not monitoring some detectors with cameras and/or not being able to enter TMS to view alarm activation since CO was present in the TMS.

When the roll-up door was open, the earliest activation recorded by staff occurred 20 minutes after the generator was started. When the roll-up door was closed, the earliest activation recorded by staff occurred approximately 13 minutes after the generator was started. When the generator was placed under the TMS, three of four CO alarms on the generator activated; but none of the CO alarms in the TMS above activated.

Sometimes, CO alarms located relatively far from the generator alarmed prior to those closest to or located on the generator. Generally, the alarms located relatively far away activated 5 to 10 minutes before the alarms located on the generator activated. Often during testing, the highest CO concentrations in the TMS were located away from the generator. Generally, as the tests progressed, the CO concentrations throughout the TMS would become more uniform. Implications for an enclosure are: (1) that CO may migrate and build up on the far side of a room more quickly than at locations near the source, due to the buoyancy of the hot exhaust gases and convective currents caused by the exhaust direction; and (2) someone standing in the room away from the generator near the walls may receive more CO exposure than someone lying down and/or near a window in the same room or closer to the source.

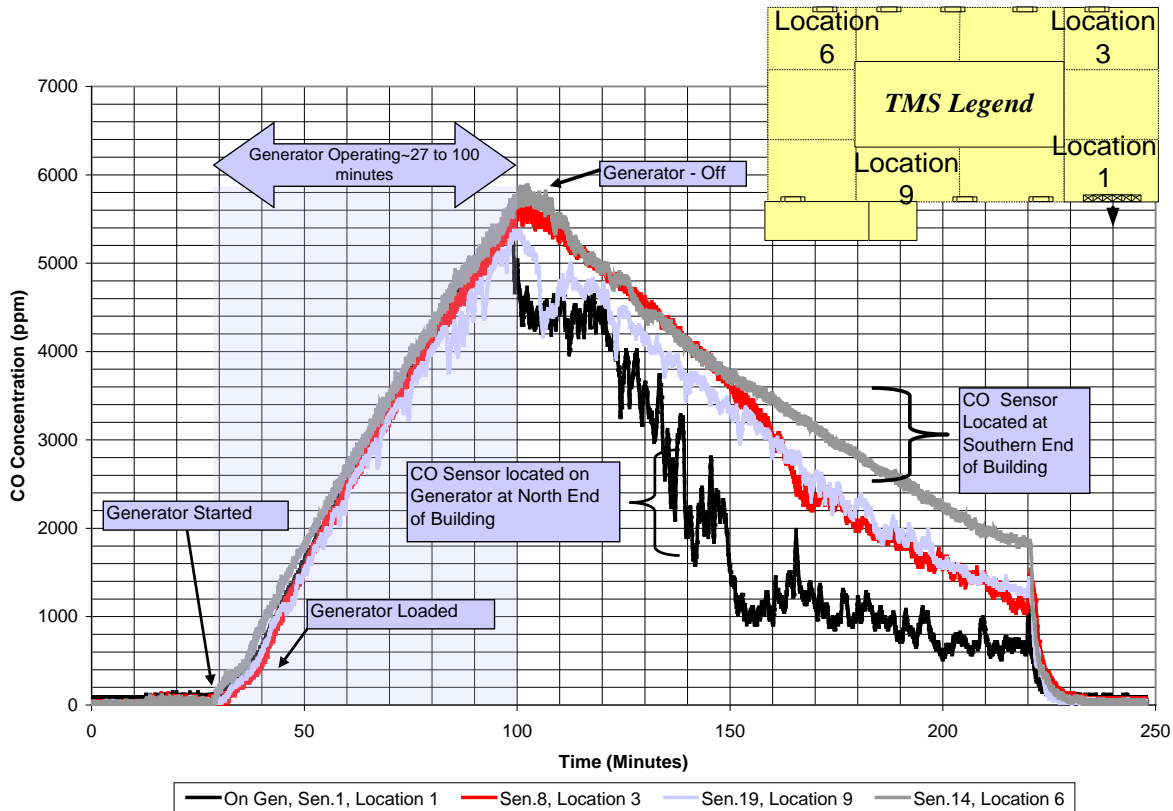
Figures 16 and 17 show the CO concentration versus time for the extreme test conditions: (1) vents and roll-up door open, and 2) vents and roll-up door closed. These graphs show the typical pattern for the tests conducted in the TMS. Up to approximately 30 minutes of data were collected before the generator was started. Note the scale of the graphs and the CO levels are different between Figures 16 and 17.

For the door-open condition shown in Figure 16, peak CO levels were about 250 ppm after about 40-50 minutes of generator operation. For the closed-door test shown in Figure 17, CO levels exceeded 1,200 ppm in about 15 minutes, reaching nearly 6,000 ppm in less than 70 minutes. CO concentrations would have been much higher had the generator not been turned off. Note the order of magnitude scale differences for CO concentration between Figures 16 and 17.



**Figure 16: Test 3a.1, Roll-Up Door & Vents Open, 10/03/05, Generator in TMS**

Sensor 2, located on the generator, moving average over 2 minutes shown on chart rather than raw data.



**Figure 17: Test 4a.3, Roll-Up Door & Vents Closed, 10/06/05, Generator in TMS**

## 5.2 Tests with SSD

Initially, three CO alarms were incorporated into the SSD. The CO alarms were all located on the sides of the generator where the exhaust did not vent. However, after several tests, one of the CO alarms incorporated into the SSD was removed due to a malfunction.<sup>13</sup> The malfunctioning CO alarm (Model 1, No. 4) was replaced with another residential (Model 2) CO alarm.

### 5.2.1 Outdoor Tests (1b and 2b)

When operating the generator in an open area (courtyard) under acceptable conditions as defined by the manufacturer,<sup>14</sup> the CO alarms located on the generator did not activate. However, as shown in Table 6, four alarms not mounted on the generator did activate during the 5-hour 25-minute test. The four alarms located directly in line with the generator exhaust activated in approximately 44 minutes after the generator was started. Two of the CO alarms that activated were located 3.0 m (10 ft) away from the generator.

When the generator was placed under the two-sided roofed shelter and the generator exhaust was directed away from the generator into the courtyard, six alarms activated over the nearly 3-hour test. None of the activating CO alarms was located on the generator. When the generator's exhaust was directed toward one of the walls of the shelter, at least one CO alarm on the generator activated and the

<sup>13</sup> The CO alarm was later found to activate properly, but the data transfer interface between the SSD and this alarm was not working consistently.

<sup>14</sup> "Start and run engine outdoors. Do not start or run the engine in an enclosed area, even if doors and windows are open." There were no definitions of what constitutes an "enclosed area" in the manufacturer's literature.

SSD shut off the generator 1 hour and 56 minutes after the generator was started. No CO alarms located away from the generator activated during the test. This contrasts with earlier tests under the two-sided roofed shelter where the generator-mounted CO alarms activated in 29 min and 48 min and two to three CO alarms not located on the generator alarmed. This difference in results was most likely due to wind direction and speed. Average temperatures during outdoor testing near the generator ranged from 21° C to 24° C (70° F to 75° F). The tests were performed in late October and early November 2005.

### **5.2.2 Indoor (TMS and M-Chamber) Tests (3b, 4b, 5b, 6b and 7b)**

When testing inside the TMS, the SSD shut the generator off, but the CO alarms incorporated into the SSD were not the first to activate. When testing in the TMS, 75 percent to 100 percent of the CO alarms activated during testing. The CO alarms located on the generator were never the first to activate. Those located at the southern and northwestern locations in the TMS tended to be among the first to alarm. This is most likely due to the hot exhaust gases, which contain high concentrations of CO, rising and flowing along the ceiling of the TMS to the opposite southern wall and the northwestern corner. When the roll-up door was closed, the SSD shut off the generator in under 14 minutes and within 2 minutes of the first activation of a non-generator-mounted CO alarm. When the roll-up door was open, shutoff occurred in less than 50 minutes, approximately 11 minutes after the first non-generator-mounted CO alarm activated. Average temperatures during testing near the generator and in the TMS away from the generator ranged from 17° C to 21° C (62° F to 70° F). The tests were performed from mid-October to early November 2005.

As shown in Table 6, when the generator was placed under the TMS, the CO concentrations near the generator remained sufficiently high to cause the SSD to shut off the generator. However, the CO concentration inside the TMS did not rise enough to cause any alarms to activate. When testing inside the M-Chamber, the SSD shut off the generator in approximately 2 minutes for all four tests.



**Table 6: Summary of CO Alarm and SSD Shutoff Results**

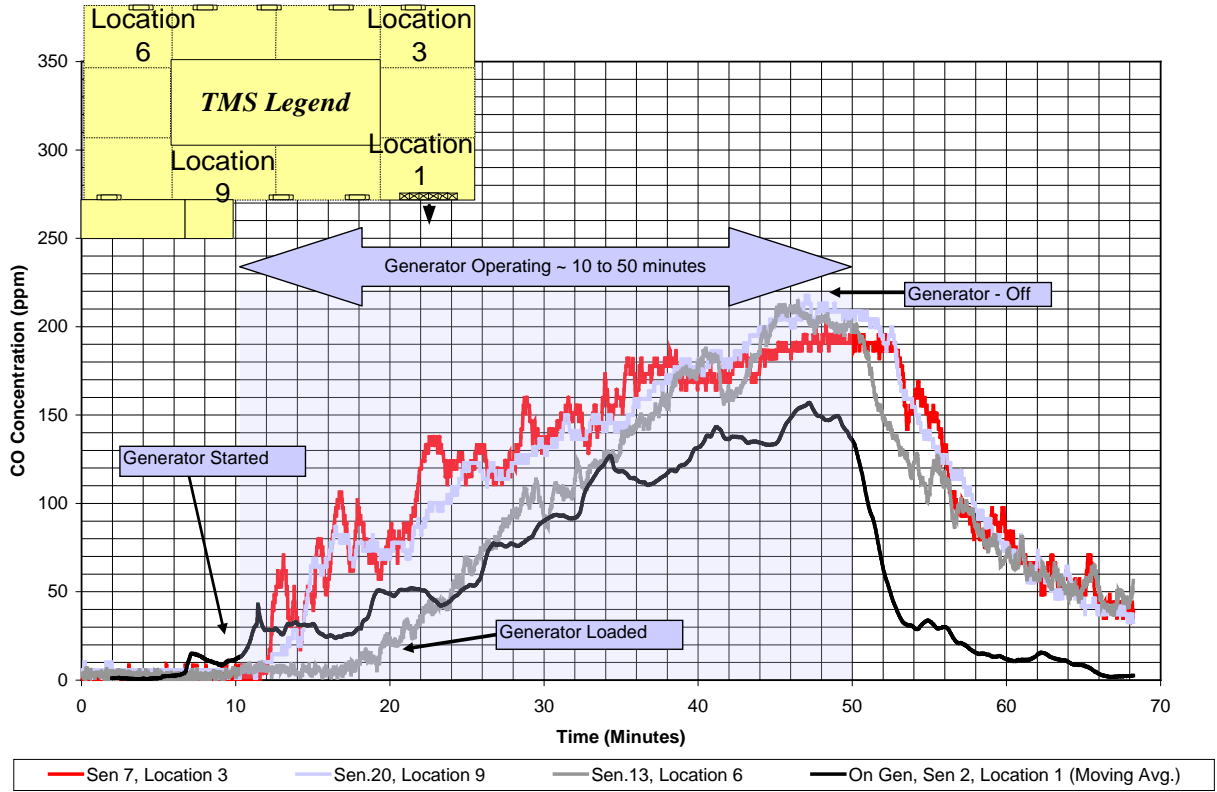
| Test ID No. | Description                                    | Number of CO Alarm Activations   | Alarm Numbers (See Figures 8, 9, 10, 11 and Appendix A) | Time of First Alarm from Start of Test (hr:min) | Time SSD Shutoff Generator (hr:min) | Range of All Alarm Peak Reading (ppm) |
|-------------|--|----------------------------------|---|---|-------------------------------------|---------------------------------------|
| 1b.1        | Courtyard                                      | 4 of 21 <sup>1</sup>             | 11, 12, 21, 22 (alarm activation order not available)   | 00:44   | None                                | 13 - 516                              |
| 2b.1        | Two-Sided Roofed Shelter-Exhaust Away From TMS | 6 of 21 <sup>1</sup>             | 15 & 16, 14, 13, 17 & 18                                | 00:11   | None                                | 44 - 999                              |
| 2b.2        | Two-Sided Roofed Shelter-Exhaust Toward TMS    | 1 of 21 <sup>1</sup>             | 1 and/or 2 <sup>2</sup>                                 | 1:56  | 1:56                                | 34 - 375                              |
| 3b.1        | In TMS, Vents Open, Roll-Up Door Open          | 6 of 8 <sup>1</sup>              | 8, 14 & 18, 2 (in SSD), 5, 9 <sup>2</sup>               | 00:31   | 00:40                               | 212 - 311                             |
| 3b.2        | In TMS, Vents Closed, Roll-Up Door Open        | 9 of 9                           | 5 & 8, 9 & 14, 2 (in SSD) 18 & 22, 11, 4 <sup>2</sup>   | 00:38   | 00:49                               | 160 - 240                             |
| 4b.1        | In TMS, Vents Open, Roll-Up Door Closed        | 9 of 9                           | 14 & 18, 4 (in SSD) & 5 & 8 & 9, 2, 11, 22 <sup>2</sup> | 00:12   | 00:14                               | 522 - 999                             |
| 4b.3        | In TMS, Vents Closed, Roll-Up Door Closed      | 22 of 22                         | 14 & 18, 2 (in SSD) <sup>2</sup>                        | 00:12   | 00:14                               | 706 - 999                             |
| 6b.1        | Under TMS, Vents Closed, Roll-Up Door Open     | 1 of 3 <sup>1</sup> , (SSD Only) | 1, and/or 4 <sup>2</sup>                                | 00:13   | 00:13                               | 134 - 748                             |
| 7b.1        | M-Chamber Test 1                               | 1 of 2 <sup>1</sup> (SSD Only)   | 1 and/or 2 <sup>2</sup>                                 | 00:02   | 00:02                               | NA <sup>3</sup>                       |
| 7b.2        | M-Chamber Test 2                               | 1 of 2 <sup>1</sup> (SSD Only)   | 1 and/or 2 <sup>2</sup>                                 | 00:01   | 00:02                               | NA <sup>3</sup>                       |
| 7b.3        | M-Chamber Test 3                               | 1 of 2 <sup>1</sup> (SSD Only)   | 1 and/or 2 <sup>2</sup>                                 | 00:01   | 00:02                               | NA <sup>3</sup>                       |
| 7b.4        | M-Chamber Test 4                               | 1 of 2 <sup>1</sup> (SSD Only)   | 1 and/or 2 <sup>2</sup>                                 | 00:01   | 00:02                               | NA <sup>3</sup>                       |

<sup>1</sup> SSD CO alarm No. 4 was removed due to malfunction (replaced for some tests with stand-alone CO alarm).

<sup>2</sup> Alarm activation and/or time of activation of remaining detectors was not discernable due to not monitoring some detectors with cameras and/or not being able to enter TMS or M-Chamber to view alarm activation because high levels of CO were present in the TMS and M-Chamber.

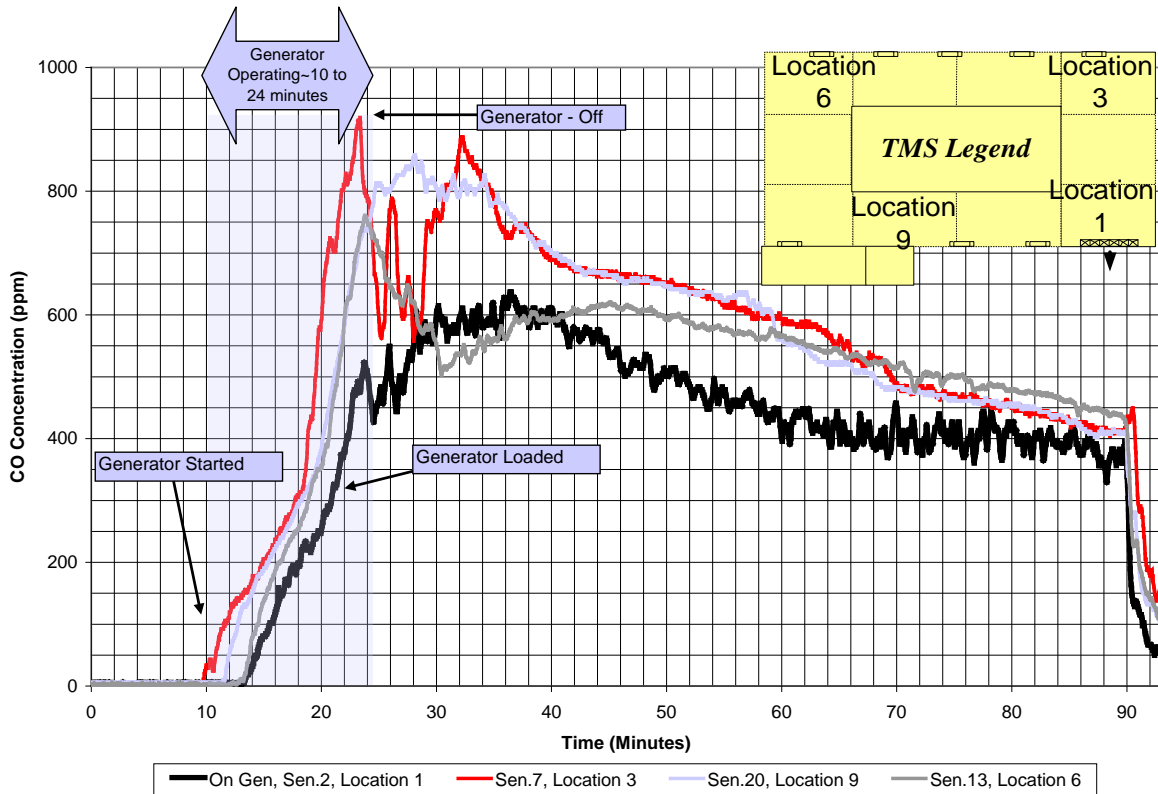
<sup>3</sup> M-Chamber tests (7b.1 – 7b.4) illustrate response of CO alarms to rapidly rising CO in a small volume. CO alarm peak readings not recorded.

Figure 18 shows the results with the SSD operational for the same open door scenario that was shown above in Figure 16. Figure 19 shows the results with the SSD operational for the closed-door scenario that was shown above in Figure 17. Although the maximum CO concentrations achieved are much higher without the SSD operational, the CO concentration remains elevated and at dangerous levels for some time, even after the SSD shuts the generator down for both tests. Up to approximately 16 minutes of data were collected before the generator was started. Sensor 2 data show significant noise before startup.



**Figure 18: SSD Test (3b.1), Roll-Up Door & Vents Open, 10/20/05, Generator in TMS**

Sensor 2, located on the generator, moving average over 2 minutes shown on chart rather than raw data.



**Figure 19: SSD Test (4b.3) Roll-Up Door & Vents Closed, 10/14/05, Generator in TMS**

### 5.3 CO Sensor Data

Table 7 summarizes the CO concentrations for the tests where CO sensors were employed. Tests where the SSD was employed tended to have significantly lower CO concentrations when the roll-up door was closed. Generally, oxygen (O<sub>2</sub>) concentrations stayed above 20 percent, except for one test where the doors and vents to the TMS were closed and the SSD was not employed. This same test had the highest recorded CO concentration. Although steady state CO was one of the initial test termination criterion, due to the unexpectedly low ACHs, all CO concentrations were still climbing at test termination for tests 3a.1 through 4b.3.

All results from the CO sensors were rounded to the nearest 50 or 100 ppm. The maximum uncertainty of the CO sensors was experimentally determined to be less than 5 percent. However, temperature variations were estimated to increase the maximum uncertainty by up to 15 percent.

As shown in Table 7, when testing outdoors with or without the SSD incorporated, the maximum CO concentration measured was approximately 800 ppm (sensor in direct path of exhaust), when the generator was tested under the two-sided roofed shelter with the exhaust pointed away from the TMS. When testing inside the TMS, with the roll-up door open, maximum CO concentrations were significantly lower than when the roll-up door was closed, reaching approximately 300 ppm (exhaust pointed out of the roll-up door) in tests where generator operation ranged between 40 minutes and slightly more than 2 hours. Opening or closing the air vents or the use of an SSD did not appear to affect greatly CO concentrations when the roll-up door was open.

When testing in the TMS with the doors and vents closed, maximum CO concentrations reached approximately 5,900 ppm in approximately 1 hour 13 minutes of generator operation without the SSD, and approximately 1,000 ppm in 14 minutes of generator operation with the SSD operational. Opening or closing the air vents greatly affected the maximum CO concentration when the roll-up door was closed. When the doors were closed, but the air vents were open, the maximum CO concentration reached approximately 2,900 ppm in 52 minutes without the SSD and 800 ppm in 14 minutes with the SSD.

When testing in the M-Chamber with an ACH of approximately 29, the maximum CO concentration measured was approximately 1,600 ppm with the generator being shutoff by the SSD in less than 3 minutes. A chamber ACH of 29 in the 9.59 m<sup>3</sup> (339 ft.<sup>3</sup>) M-Chamber is equivalent to 0.82 ACH in a 339.8 m<sup>3</sup> house (approximately 1,500 ft<sup>2</sup> with 8 ft ceilings, or 12,000 ft<sup>3</sup>). Although the airflow may be the same in the chamber as in a house, the CO rises much faster in the chamber, due to the smaller volume. Essentially, the M-Chamber tests explore the operation of two models of off-the shelf residential CO alarms under conditions of rapidly rising CO from generator exhaust.

**Table 7: Summary of Gas Concentrations for Tests with CO Sensors and Portable Analyzers**

| Test Id   | Description                                    | SSD Equipped (Yes/No) | CO Max (ppm)      | O <sub>2</sub> <sup>1</sup> Minimum (%) | Generator Operation Time (hrs:min) |
|-----------|--|-----------------------|-------------------|---|------------------------------------|
| 1b.1      | Courtyard                                      | Yes                   | 650               | 20.9                                    | 5:25                               |
| 2b.1      | Two-Sided Roofed Shelter-Exhaust Away From TMS | Yes                   | 800               | 20.9                                    | 2:56                               |
| 2b.2      | Two-Sided Roofed Shelter-Exhaust Toward TMS    | Yes                   | 450               | 20.7                                    | 1:56                               |
| 3a.1      | In TMS, Vents Open, Roll-Up Door Open          | No                    | 300               | 20.5                                    | 00:48                              |
| 3a.2      | In TMS, Vents Open, Roll-Up Door Open          | No                    | 300               | 20.7                                    | 00:52                              |
| 3b.1      | In TMS, Vents Open, Roll- Up Door Open         | Yes                   | 300               | 20.7                                    | 00:40                              |
| 3a.3      | In TMS, Vents Closed, Roll- Up Door Open       | No                    | 250               | 20.7                                    | 00:58                              |
| 3a.4      | In TMS, Vents Closed, Roll- Up Door Open       | No                    | 300               | 20.8                                    | 02:03                              |
| 3b.2      | In TMS, Vents Closed, Roll- Up Door Open       | Yes                   | 250               | 20.7                                    | 00:49                              |
| 4a.1      | In TMS, Vents Open, Roll- Up Door Closed       | No                    | 2600              | 20.2                                    | 00:50                              |
| 4a.2      | In TMS, Vents Open, Roll- Up Door Closed       | No                    | 2900              | 20.1                                    | 00:52                              |
| 4b.1      | In TMS, Vents Open, Roll- Up Door Closed       | Yes                   | 800               | 20.4                                    | 00:14                              |
| 4a.3      | In TMS, Vents Closed, Roll- Up Door Closed     | No                    | 5900              | 19.5                                    | 01:13                              |
| 4b.3      | In TMS, Vents Closed, Roll- Up Door Closed     | Yes                   | 900               | 20.6                                    | 00:14                              |
| 5a.1/6a.1 | Under TMS, Vents Closed, Roll- Up Door Closed  | No                    | 1100              | NA                                      | 01:05                              |
|           | Under TMS, Vents Closed, Roll- Up Door Open    | No                    | 1100              | NA                                      | 00:50                              |
| 6b.1      | Under TMS, Vents Closed, Roll- Up Door Open    | Yes                   | 900               | 20.1                                    | 00:13                              |
| 7b.1      | M-Chamber Test 1                               | Yes                   | 1200 <sup>2</sup> | 20.5                                    | 00:02                              |
| 7b.2      | M-Chamber Test 2                               | Yes                   | 900 <sup>2</sup>  | 20.6                                    | 00:02                              |
| 7b.3      | M-Chamber Test 3                               | Yes                   | 1600 <sup>2</sup> | 20.4                                    | 00:01                              |
| 7b.4      | M-Chamber Test 4                               | Yes                   | 1400 <sup>2</sup> | 20.4                                    | 00:01                              |

- O<sub>2</sub> measured by up to three portable analyzers sampling at generator location.
- Maximum CO concentrations may be somewhat higher, but not captured due to high ACH and not achieving equilibrium conditions at the time the SSD shut off the generator.

**Notes:** Tests 1a and 2a are not in Table 7 because they did not have sensors, only CO alarms and three portable analyzers. Tests 3a.1 through 4b.3 were terminated before equilibrium was attained.

The magnitude and duration of CO concentrations throughout the TMS were highly dependent on the ventilation (ACHs) throughout the TMS. Since the TMS building’s air was generally not well mixed, the air influx from the vents, windows, and doors influenced the ACHs throughout the TMS. The ACH at various locations in the TMS was calculated for the test results shown in Figures 16, 17, 18, and 19. Table 8 displays the calculated ACHs for these tests. As expected, the ventilation was much more uniform when the TMS door and overhead air vents were closed, but the ventilation varied considerably when the roll-up door was open. The average ACHs in the tables were calculated from the recorded CO concentrations, but the overall ACH in the building may have varied considerably from the calculated averages due to the lack of mixing in the building and the various small openings in the building near doors and one window. These calculated ACHs are intended as indicative guides to air flow variation and are not representative of precise values.

The time range over which the ACH is calculated in some cases greatly affects the ACH result, depending upon the location of the measurement, and the type of test. As an example (See Table 8), the ACH in Location 1 was calculated over two time ranges (approximately 4 minutes and nine minutes), one range being a subset of the other range.<sup>15</sup>

Up to approximately 1.4 hours of CO decay data were used in the ACH calculations for the closed-door tests.<sup>16</sup> The lower magnitude ACHs correspond to longer time ranges. When there are two values in the “Location 1” column, they show the ACHs over the two previously mentioned time ranges. In addition, the two values in the rightmost or “Average” column reflect the averages of the four values in the Location 3 through Location 9 columns and each of the values in the Location 1 column.

The CO decay times occasionally showed several distinct patterns depending on the location of the sensor. Sensor data, CO alarm data, and alarm activation information suggested that CO might have been stratified in the TMS. Generally, the CO concentrations rose first at the southern end and northwestern corner of the building, away from the generator (northeastern corner); and they dropped more quickly at the roll-up door near the generator (northeastern corner of TMS) at the end of a test. In addition, the CO concentrations farthest away from the roll-up door fell in a uniform manner. Figure 12 shows the locations of the sensors and the alarms that were used in the calculations of the ACH that are each of the ACHs presented in Table 8.

**Table 8: Localized ACHs from Five Locations in the TMS for the Four Tests Presented in Figures 16 to 19**

|   | Location 1 | Location 3 | Location 6 | Location 7 | Location 9 | Average of Five ACHs |
|---|------------|------------|------------|------------|------------|----------------------|
| ACHs for Test 3a.1, Door Open, Vents Open, 10/03/05     | 16.6/8.5   | 5.6        | 3.0        | 3.3        | 5.4        | 6.8/5.2              |
| ACHs for Test 4a.3, Door Closed, Vents Closed, 10/06/05 | 1.33       | 0.91       | 0.57       | 0.65       | 0.76       | 0.84                 |
| ACHs for SSD Test 3b.1, Door Open, Vents Open, 10/20/05 | 29.7/15.4  | 5.6        | 6.7        | 4.9        | 7.0        | 10.8/7.9             |
| ACHs for SSD Test 4b.3, Door                            | 0.51       | 0.57       | 0.45       | 0.44       | 0.79       | 0.55                 |

<sup>15</sup> Since the TMS air was not well mixed, the higher CO concentrations from across the TMS would migrate to the opening and raise the CO concentrations at the opening after the first few minutes of the decay, making the ACH appear high when data after the first few minutes were included. See Figure 18 Sensor 2’s slope change at approximately 53 minutes. Thus, near the opening, ACH data were collected over a much shorter time than at other locations in the TMS. Note: See Figure 18 Sensor 2’s slope change at approximately 53 minutes.

<sup>16</sup> Normally, a period corresponding to an approximate 95 percent decay level would be preferred (determined through evaluation of the time constant of the logarithmic CO decay); however, collection of decay data over the longer periods required for such an evaluation was not possible.

## 6 DISCUSSION OF TEST RESULTS

The results of the outdoor testing showed that, even when the generator was operated in a courtyard, CO alarms might be activated by high levels of CO in the generator's exhaust. While not activating any CO alarms located on the generator, CO concentrations located immediately around the generator ranged up to nearly 350 ppm in the outdoor testing scenario (based on results of Test 1a.3 shown in Figure C1 in Appendix C). These patterns are typical of how CO concentrations vary significantly in close proximity to the generator when operating in the open area of the courtyard, under a light breeze condition. Similarly, when placed in a two-sided roofed shelter, some CO alarms activated in response to hazardous CO concentrations caused by the generator's exhaust.

When the SSD was mounted on the generator, it *always* shut off the generator when there were hazardous CO levels around the generator and the generator was located in an enclosed area. The SSD also shut off the generator when it was operated in the two-sided roofed shelter and the exhaust was directed toward a wall of the shelter. For the TMS testing, migration and stratification of CO levels was observed. In addition, staff observed that CO alarms on the generator that were incorporated into the SSD were not the first CO alarms inside the TMS that activated during several tests, likely a result of the migration and stratification of the hot exhaust gases.

Results from tests in the M-Chamber and in the TMS with the roll-up door and vents closed showed rapidly increasing CO concentrations. Test results show that the CO levels may remain at hazardous concentrations for some time after the generator shuts off. The following observations and conclusions were made based on the test results:

- 1) The 5.5 kW generator produced CO concentrations:
  - a. sufficient to set off CO alarms 5 feet and 10 feet away when tested outdoors;
  - b. sufficient to cause CO alarms mounted on the generator to activate when run outdoors in a two-side roofed structure, or in a crawl space under the TMS; and
  - c. that can rapidly become lethal when the generator is operated indoors.
- 2) A Safety Shutoff Device (SSD) that incorporated CO alarms shut off a generator.
- 3) Potentially hazardous CO concentrations may remain present in an enclosed space even after an SSD shuts off a generator, depending on the enclosure size, mixing and ventilation, and other environmental conditions. Thus, an SSD needs to incorporate an alarm as well as shut off a generator.
- 4) CO concentrations varied considerably in the TMS, depending on the ventilation conditions and location (distance from generator, height above floor level, and/or proximity to an open/closed window or door).
- 5) It may be necessary to develop generator specific shut-off criteria for an SSD-type intervention device. The SSD used in the staff testing relied on CO alarms listed to UL 2034. These alarms still allowed CO levels to reach dangerously high levels in certain test scenarios. The activation criteria for CO alarms used in a generator-mounted SSD will likely need to account for generator-specific rapidly rising CO concentrations and the decay of CO from those levels.
- 6) It will be necessary to consider the harsh environment around a generator when developing an SSD. Sensors will need to be robust to withstand the repeated exposure to high vibration levels and temperature variations.
- 7) The design criteria for any type of SSD system for generators would need to consider that the CO may be at higher levels away from the generator and thus may need to consider both an on-board

and a remote sensor unit that is located indoors near the generator user(s). The use of two or more CO sensors in an SSD system should be considered.

## 7 ACKNOWLEDGMENTS

This project was completed with the help of CPSC staff in the Directorate for Laboratory Sciences, Directorate for Engineering Sciences, Directorate for Epidemiology, Directorate for Health Sciences, Directorate for Economics Analysis, and Directorate for Field Operations.

**Contributors:** David Tucholski, Warren Porter, Janet Buyer, Donald Switzer, James Hyatt, Sandy Inkster, Arthur Lee, Ted Gordon (contributing writer & electrical designer), Hugh McLaurin, Andrew Stadnik, and Linda Edwards

**Design and Construction of Test Chamber & Setups:** Thomas Hardison, Mark Eilbert, Perry Sharpless, Duncan Snyder, and John Gilmore.

**Programming:** Dean LaRue

## 8 REFERENCES

- Brown, C.J. (July 2004). *Medium Sized Combustion Chamber System Characterization Tests*. Gaithersburg, MD; U.S. Consumer Product Safety Commission.
- Brown, C. J. (December 2006). *Engine-Driven Tools Phase 1 Test Report for Portable Electric Generators*. Gaithersburg, MD; U.S. Consumer Product Safety Commission
- Grot, R. & Lagus, P. (1991). *Application of Tracer Gas Analysis to Industrial Hygiene Investigations*. Olney, MD; Lagus Applied Technology, Inc.
- Hnatov, M. (October 10, 2007). *Incident, Deaths, and In-Depth Investigations Associated with Non-Fire Carbon Monoxide from Engine-Driven Generator and Other Engine-Driven Tools, 1999-2006*. [Memorandum]. Bethesda, MD; U.S. Consumer Product Safety Commission.
- Inkster, S. (September 21, 2004). *Health hazard assessment of CO poisoning associated with emissions from a portable, 5.5 kilowatt, gasoline-powered generator*. [Memorandum]. Bethesda, MD; U.S. Consumer Product Safety Commission.
- Marcy, N.E., Ascone, D.S. (December 1, 2005). *Incidents, Deaths, and In-Depth Investigations Associated with Carbon Monoxide and Engine Driven Tools, 1990-2004*. [Memorandum]. Bethesda, MD; U.S. Consumer Product Safety Commission.
- Nagada, N.L., Rector, H.E., & Koontz, M.D. (1987). *Guidelines for Modeling Indoor Air Quality*. New York, NY; Hemisphere Publishing Corporation.
- National Institute for Occupational Safety and Health. (1972). *Criteria for a Recommended Standard - Occupational Exposure to Carbon Monoxide, Department of Health and Human Services*, NIOSH Publication No. 73-11000. Washington D.C. U.S. Government Printing Office.
- Porter, Jr. W.K. (March 25, 2004). *Personal communication with S. Inkster, CPSC Health Sciences, regarding modeled CO Concentrations from engine-powered generators*. Gaithersburg, MD; U.S. Consumer Product Safety Commission.
- Steinberg, S. and Neilson, G.D. (March 1997). *A Proposal for Evaluating Human Exposure to Carbon Monoxide Contamination in Military Vehicles*, AMCMS Code 672716.H700011.
- Underwriters Laboratories Inc. (June 2002). *Standard for Safety for Single and Multiple Station Carbon Monoxide Alarms (UL 2034)*. Northbrook, IL.
- U.S. Environmental Protection Agency. (July 1, 2005). *Title 40 U.S. Code: Protection of the Environment, Part 90, Subpart B, Section 103; Control of Emissions from Nonroad Spark-Ignition Engines at or Below 19 Kilowatts*. [Retrieved Online] December 16, 2005. GPO Access. [[http://www.access.gpo.gov/nara/cfr/waisidx\\_05/40cfr90\\_05.html](http://www.access.gpo.gov/nara/cfr/waisidx_05/40cfr90_05.html)].



**APPENDIX A: TEST FACILITIES PHOTOS AND SCHEMATICS**



**Figure A1: Courtyard Located between TMS and Test Buildings.**



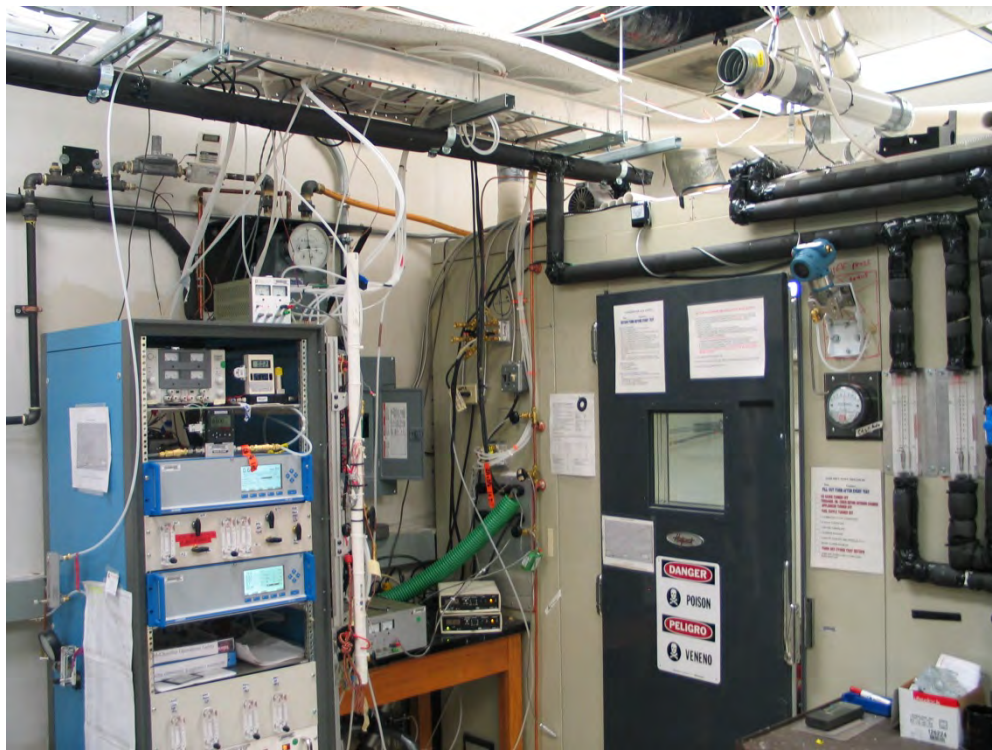
**Figure A2: Two-Sided Roofed Area Adjacent to the TMS Building**



**Figure A3: Outside View of the TMS Building with the Generator Placed Underneath**



**Figure A4: Generator in Courtyard Surrounded by Sensors and CO Alarms**

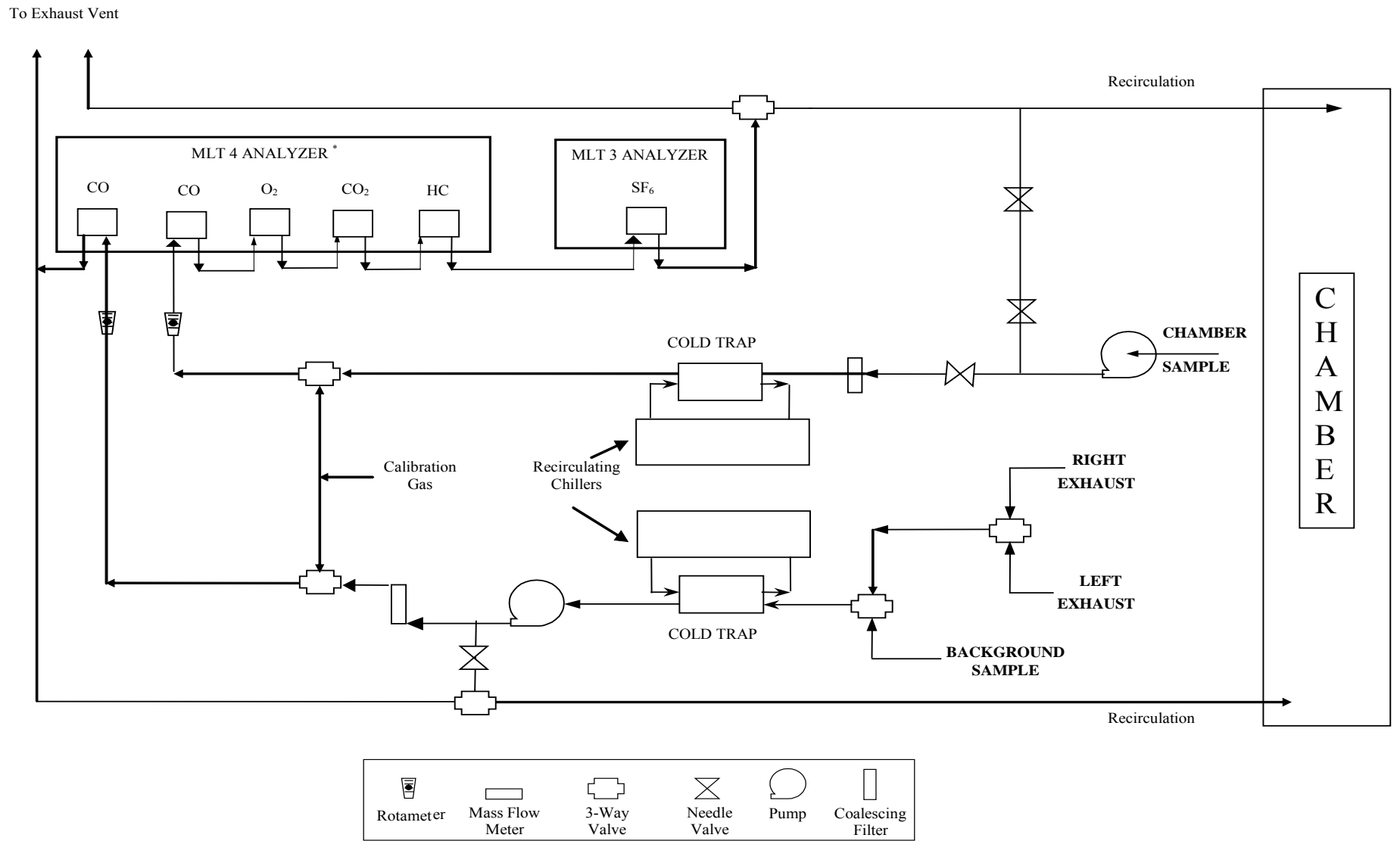


**Figure A5: Outside View of the Medium Chamber**

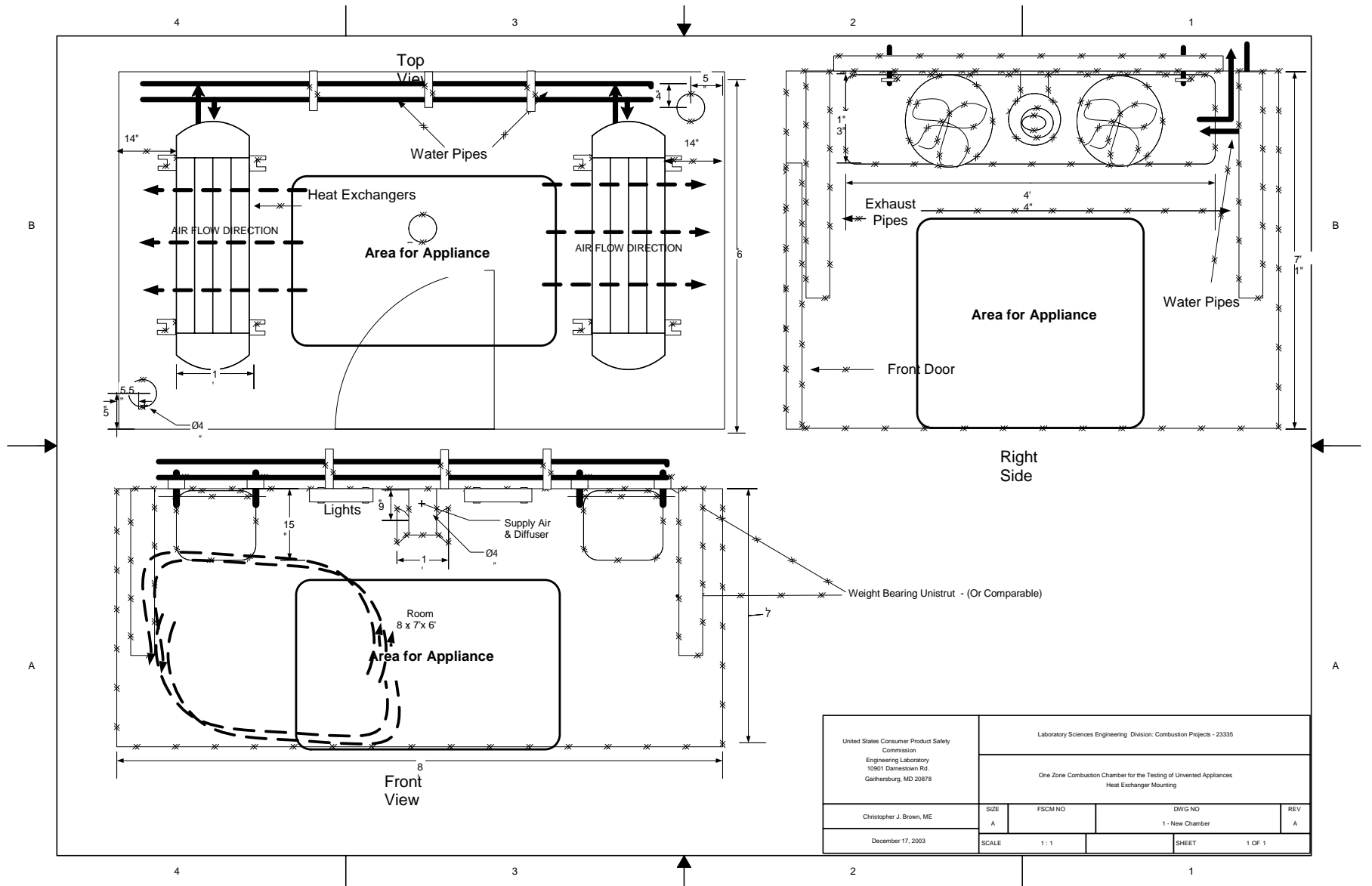


**Figure A6: Inside View of the Medium Chamber.**

Air supply pipes are located at the top center of the chamber and face the heat exchangers.



**Figure A7: Medium Chamber Gas Sampling System**



|  |   |         |                           |          |
|--|---|---------|---------------------------|----------|
| United States Consumer Product Safety Commission<br>Engineering Laboratory<br>10901 Darnestown Rd.<br>Gaithersburg, MD 20878 | Laboratory Sciences Engineering Division: Combustion Projects - 23335                         |         |                           |          |
|  | One Zone Combustion Chamber for the Testing of Unvented Appliances<br>Heat Exchanger Mounting |         |                           |          |
| Christopher J. Brown, ME   | SIZE<br>A   | FSCM NO | DWG NO<br>1 - New Chamber | REV<br>A |
| December 17, 2003  | SCALE   | 1 : 1   | SHEET                     | 1 OF 1   |

**Figure A8: Medium Chamber Schematic**

## APPENDIX B: CHAMBER TEST EQUIPMENT

**Table B1.** Equipment used to measure the different operating parameters of the chamber

| Parameter Being Measured           | Equipment Type                            | Manufacturer | Model                    | Range   | Accuracy                                      |
|------------------------------------|---|--------------|--------------------------|---|---|
| Tracer Gas Injection Rate          | Smart-Trak Mass Flow Controller-Digital   | Sierra       | Series 100               | 0-7.690 slpm CO<br>0-2.0 slpm SF <sub>6</sub> | ± 1.0% full scale                             |
| Tracer Gas Injection Rate          | Mass Flow Controller-Digital              | Sierra       | 810c-DR-2-MP             | 0-350 sccm CO<br>0-91 sccm SF <sub>6</sub>    | ± 1.0% full scale                             |
| Tracer Gas Injection Rate          | VF (Visi-Float®) Flowmeter                | Dwyer        | VFA-24-SSV<br>VFA-22-SSV | 1.0-10.0 slpm CO<br>0.15-1.0 slpm CO          | ± 5% full scale                               |
| Chamber/Room Differential Pressure | Magnehelic Pressure Gage with Transmitter | Dwyer        | 605-1                    | (-1)-1.0 inches w.c.                          | ± 2% full scale                               |
| Chamber/Room Differential Pressure | Digital Differential Pressure Transmitter | Rosemount    | 3051C                    | (-3.0)-3.0 inches w.c.                        | ± 0.075% full scale                           |
| Chamber Temperature                | Thermocouple                              | Omega        | Type K                   | -200 to 1250°C                                | 2°C or 0.75% of reading, whichever is greater |

**Table B2.** Equipment Used with the Gas Sampling Systems

| Chemical Species                       | Location           | Measuring Technique     | Manufacturer | Model            | Range                             | Accuracy        |
|--|--------------------|-------------------------|--------------|------------------|-----------------------------------|-----------------|
| Carbon Monoxide (CO)                   | Chamber (Manifold) | Non-Dispersive Infrared | Rosemount    | NGA 2000 (MLT 4) | 0-200 ppm, 0-1000 ppm, 0-7000 ppm | 1% Full Scale   |
| Carbon Monoxide (CO)                   | Outside Chamber    | Non-Dispersive Infrared | Rosemount    | NGA 2000 (MLT 4) | 0-200 ppm, 0-1000 ppm, 0-7000 ppm | 1% Full Scale   |
| Sulfur Hexafluoride (SF <sub>6</sub> ) | Chamber (Manifold) | Non-Dispersive Infrared | Rosemount    | NGA 2000 (MLT 3) | 0-63 ppm                          | 1% Full Scale   |
| Gas Divider                            | Calibration Gases  | Capillary Tube Type     | Horiba       | SGD-A10          | 10-point, 0-100%                  | 0.5% Full Scale |

## **APPENDIX C: SELECTED TEST DATA CHARTS**

Note: CO concentrations for Figures C1 through C3 measured with portable analyzers and do not reflect high noise levels, but are accurate CO concentrations.



Figure C1: Center Courtyard Test, 1st Outdoor Test, ID 1a.1, 7/15/2005

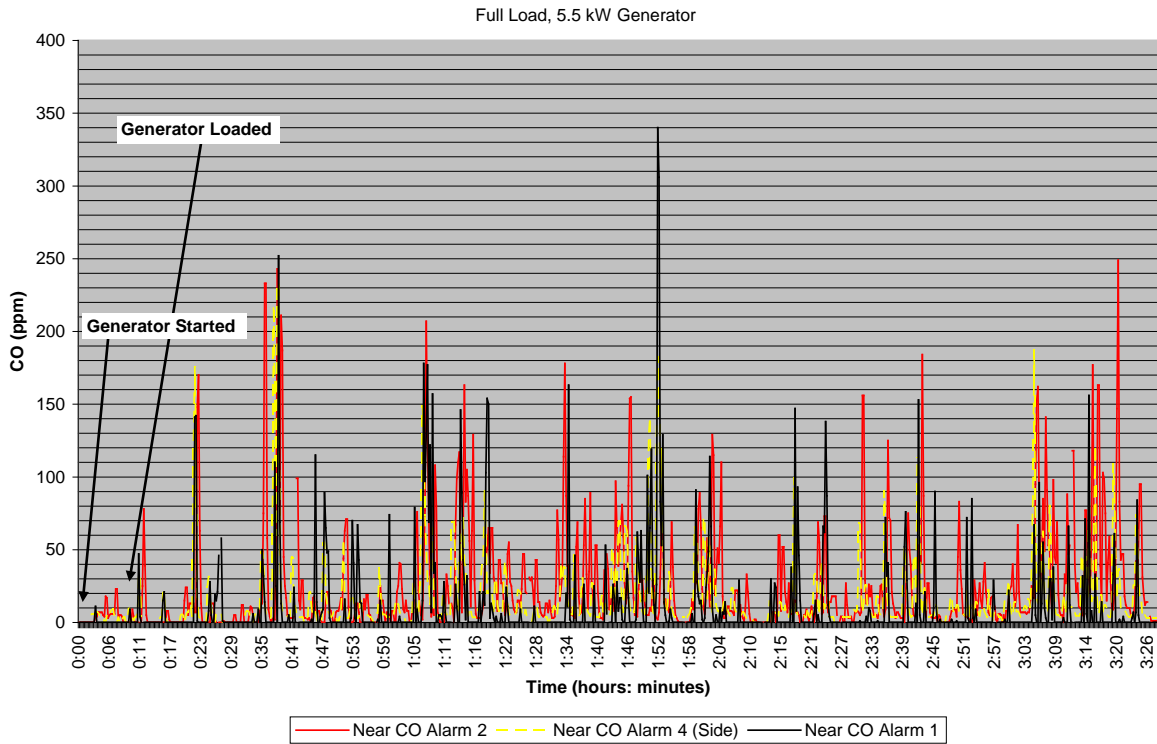


Figure C2: Two-Sided Shelter - Exhaust to Courtyard, 6th Outdoor Test, ID 2a.2, 7/21/2005

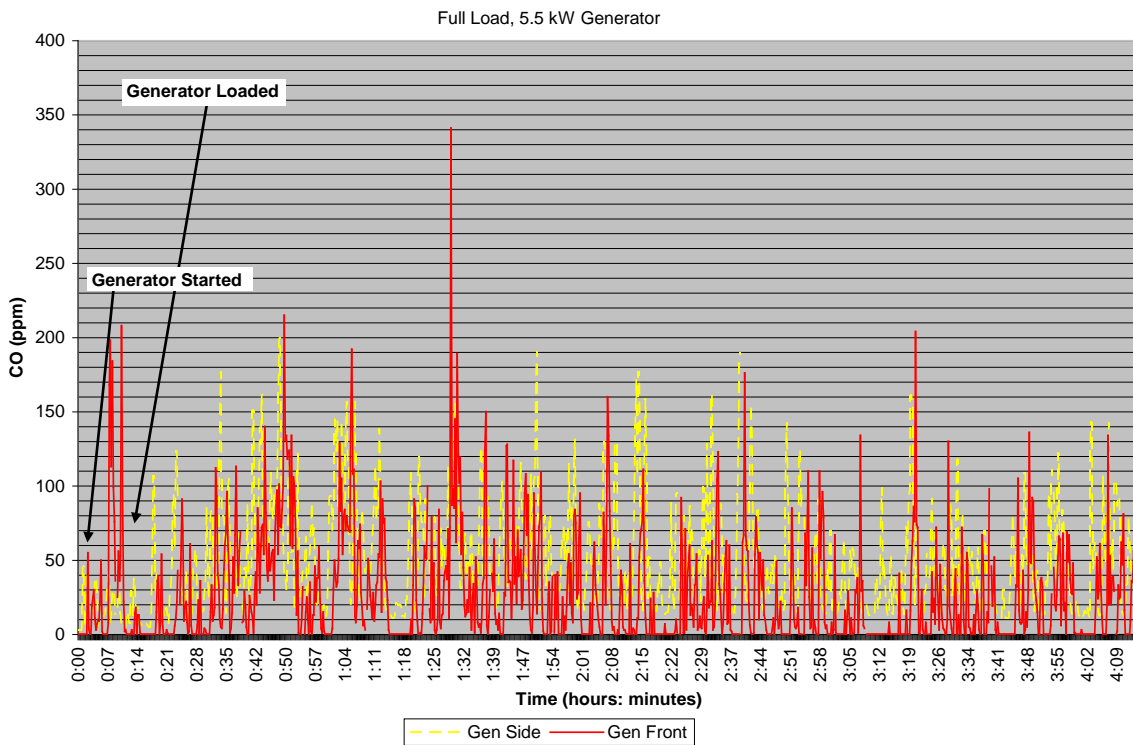


Figure C3: Two-Sided Shelter - Exhaust to TMS Wall, 8th Outdoor Test, ID 2a.4, 8/01/2005

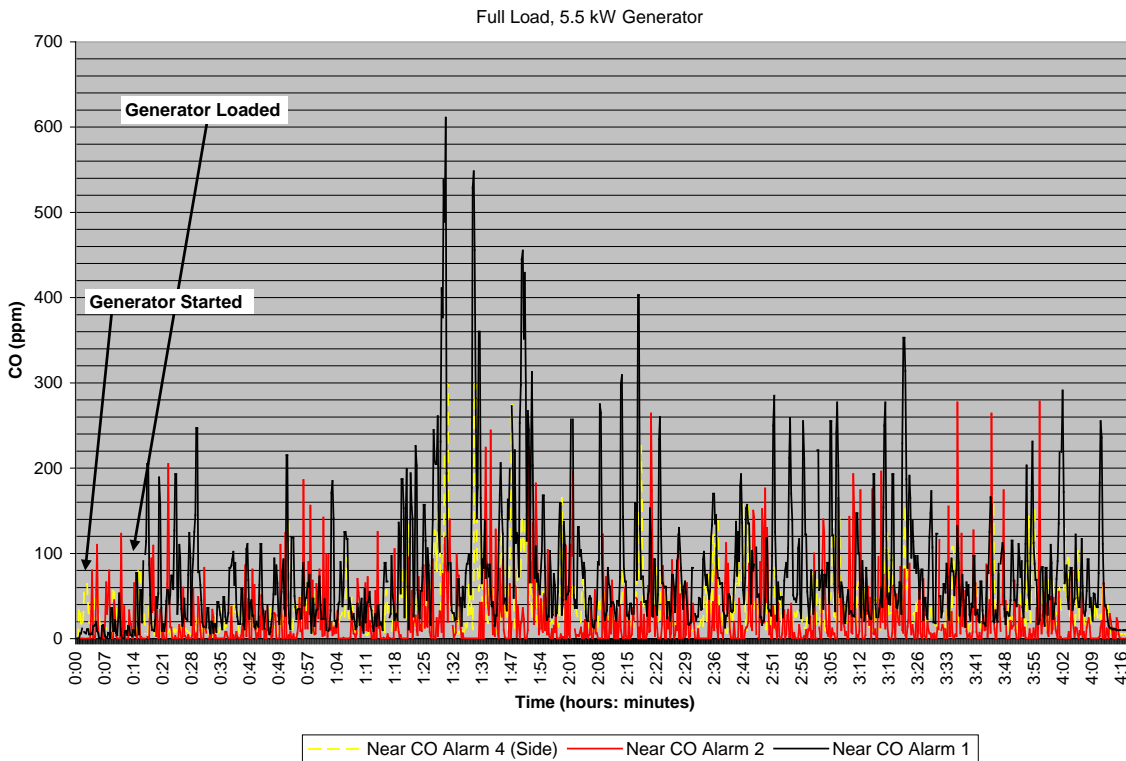
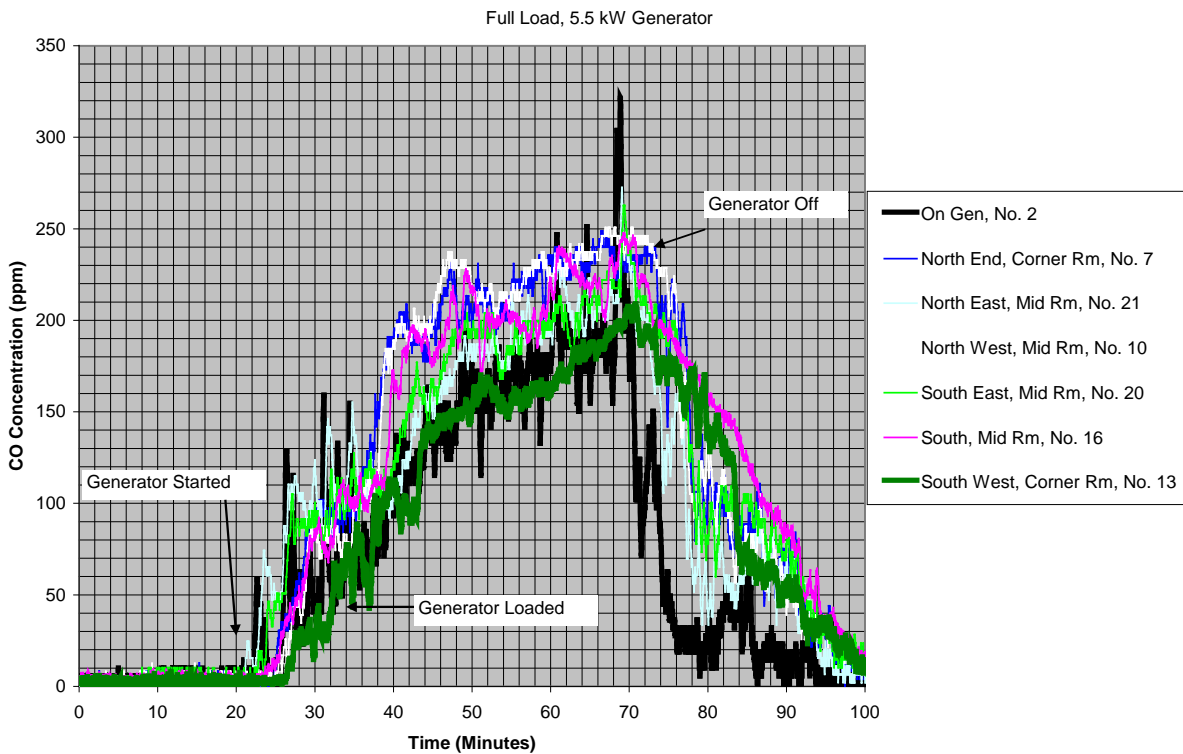
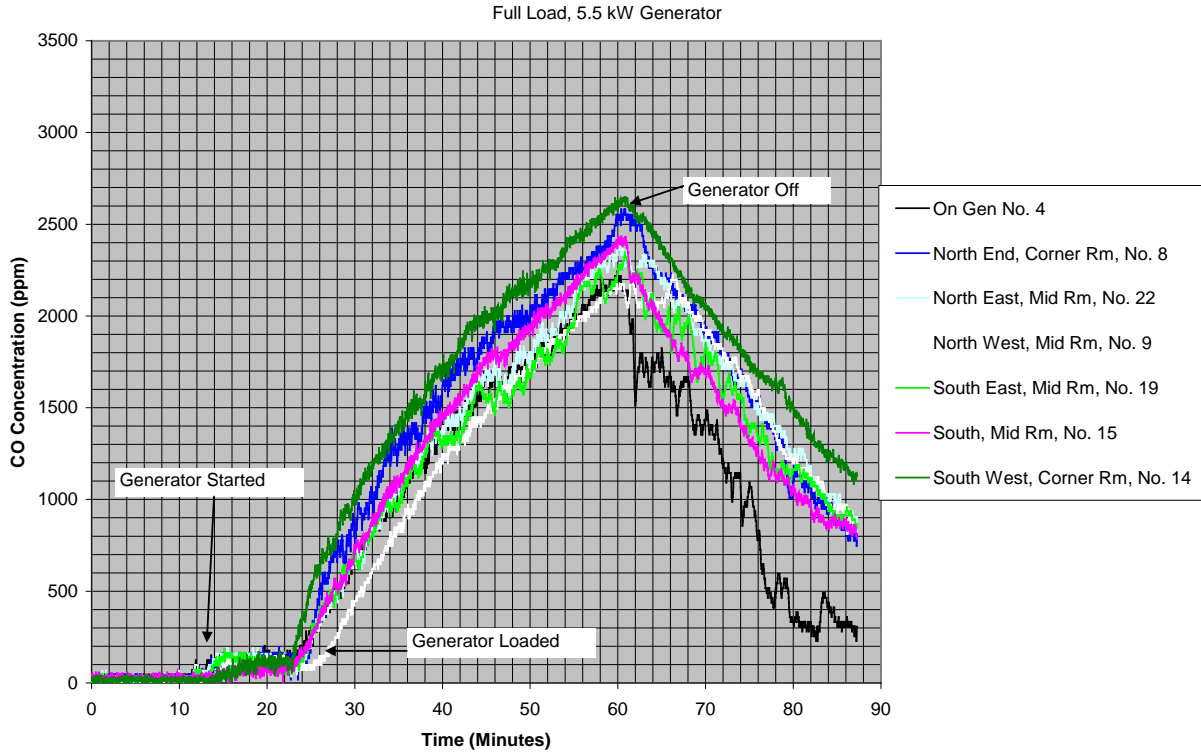


Figure C4: Inside TMS, Door and Vents Open, Test ID 3a.1, 10/03/05



**Figure C5: Inside TMS, Door Closed and Vents Open, Test ID 4a.1, 10/03/05**



**Figure C6: Inside TMS, Door and Vents Open, Test ID 3a.2, 10/05/05**

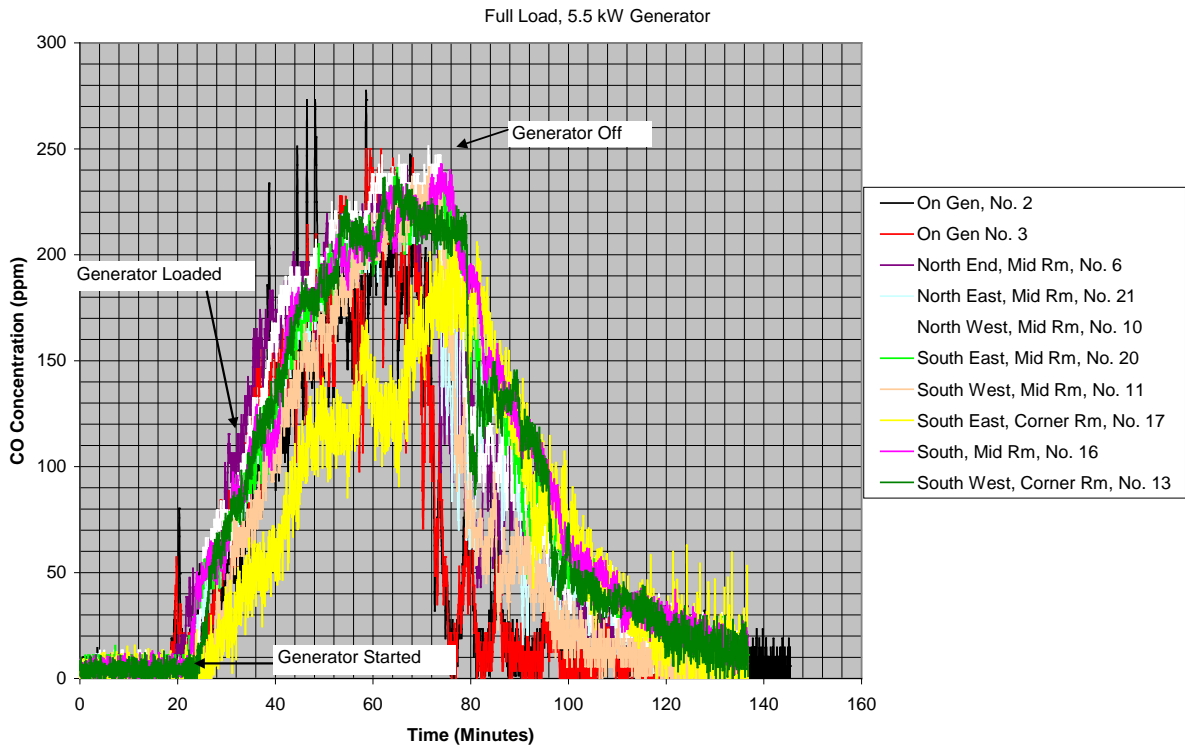


Figure C7: Inside TMS, Door Closed and Vents Open, Test ID 4a.2, 10/05/05

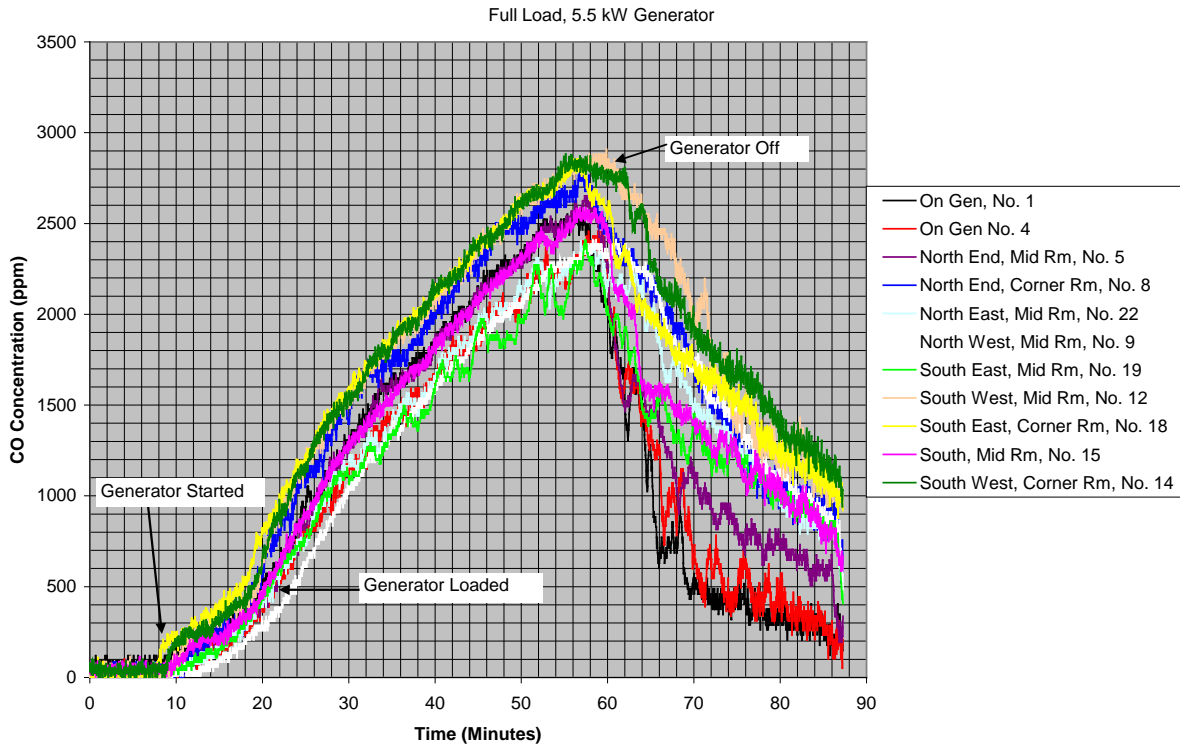


Figure C8: Inside TMS, Door Open and Vents Closed, Test ID 3a.3, 10/06/05

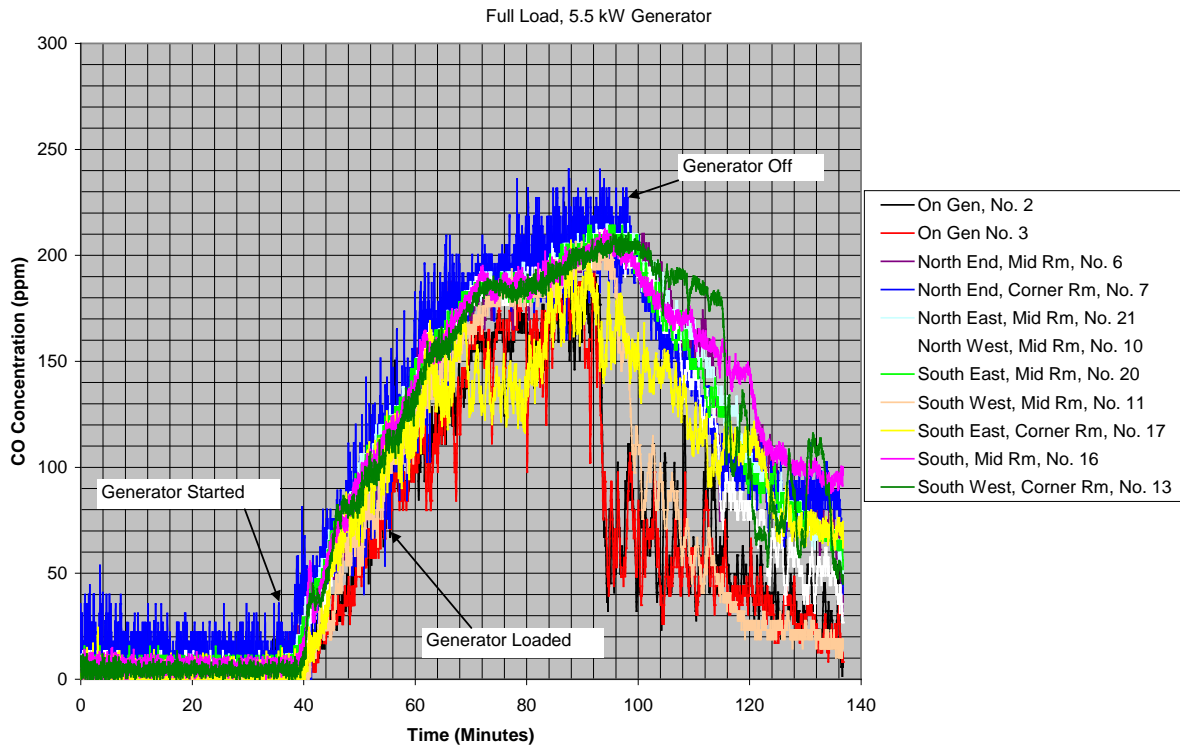


Figure C9: Inside TMS, Door and Vents Closed, Test ID 4a.3, 10/06/05

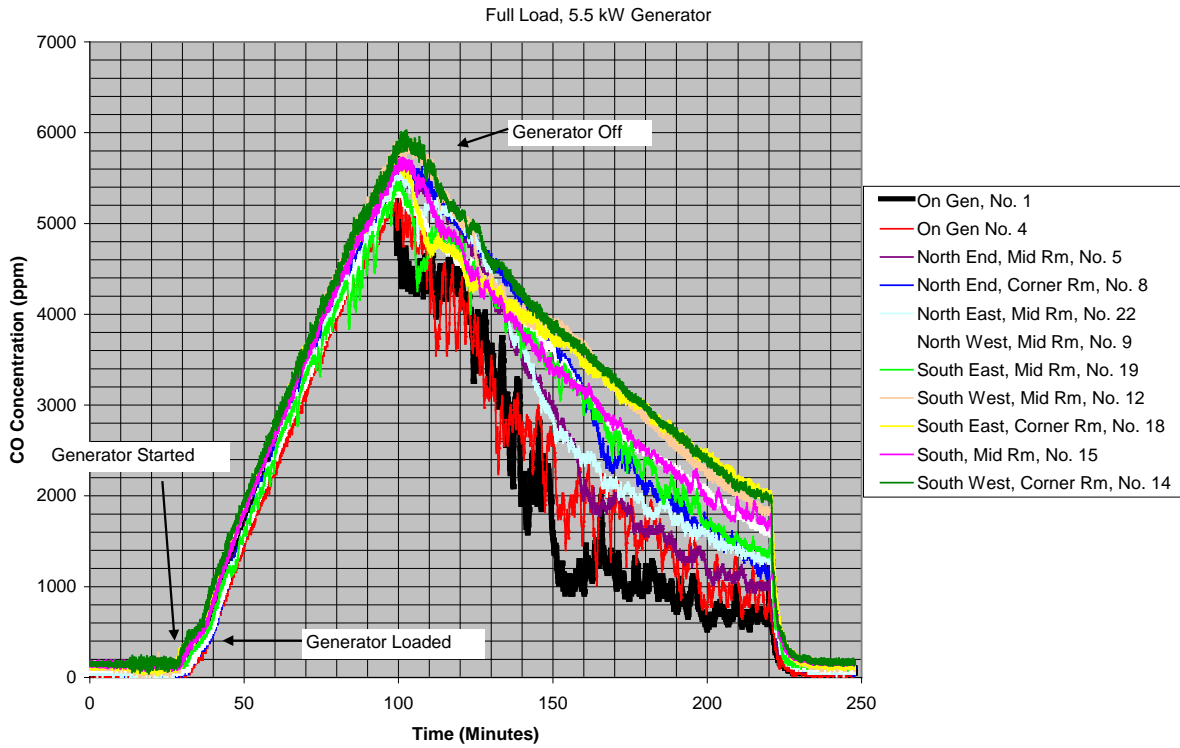
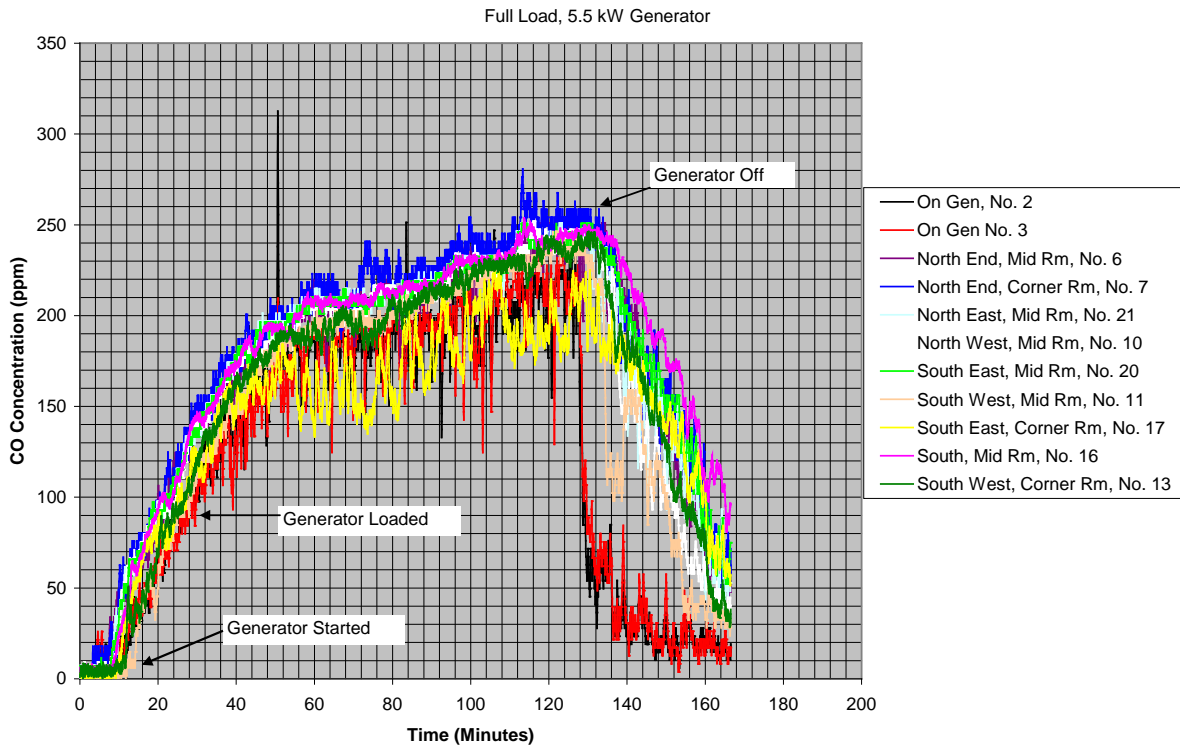
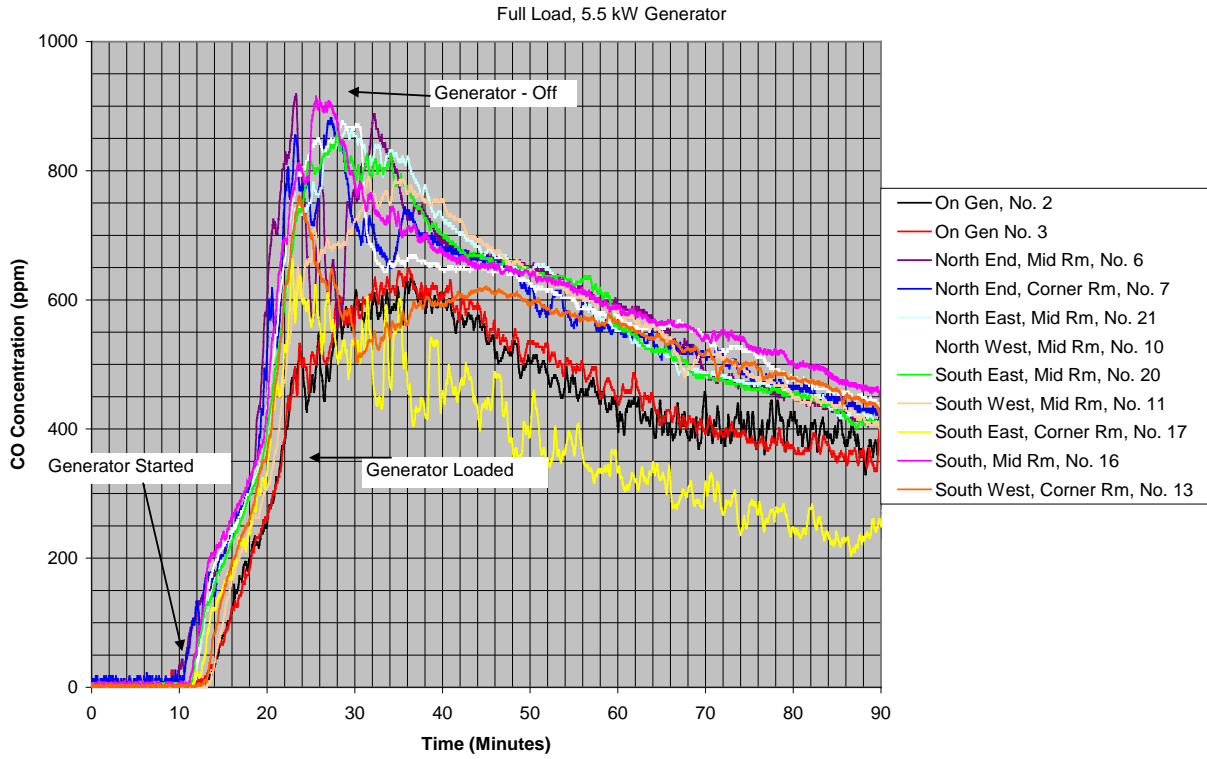


Figure C10: Inside TMS, Door Open and Vents Closed, Test ID 3a.4, 10/12/05



**Figure C11: Inside TMS, Door and Vents Closed, SSD Test 1, Test ID 4b.3, 10/14/05**



**Figure C12: Inside TMS, Comparison of Two Tests, Test ID 4a.3 & 4b.3, Both With Door and Vents Closed, 10/06/05 & 10/14/05**

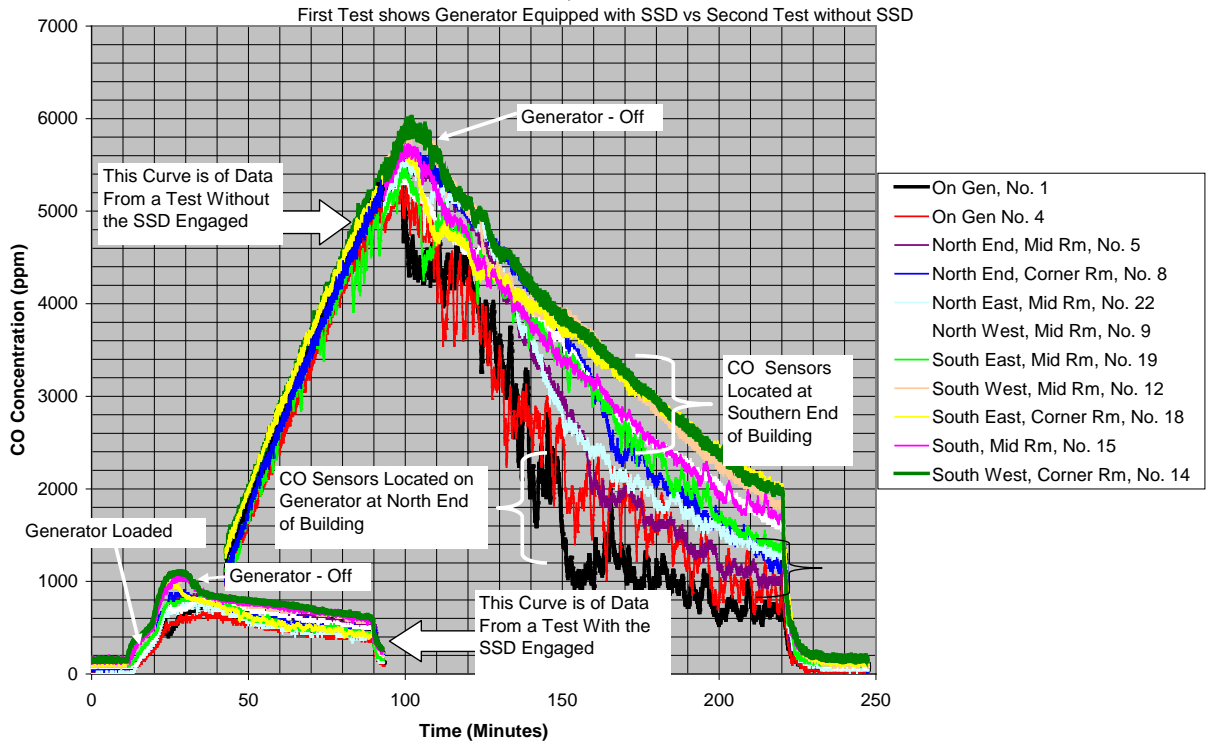


Figure C13: Inside TMS, Door Open and Vents Closed, SSD Test 2, Test ID 3b.2, 10/18/05

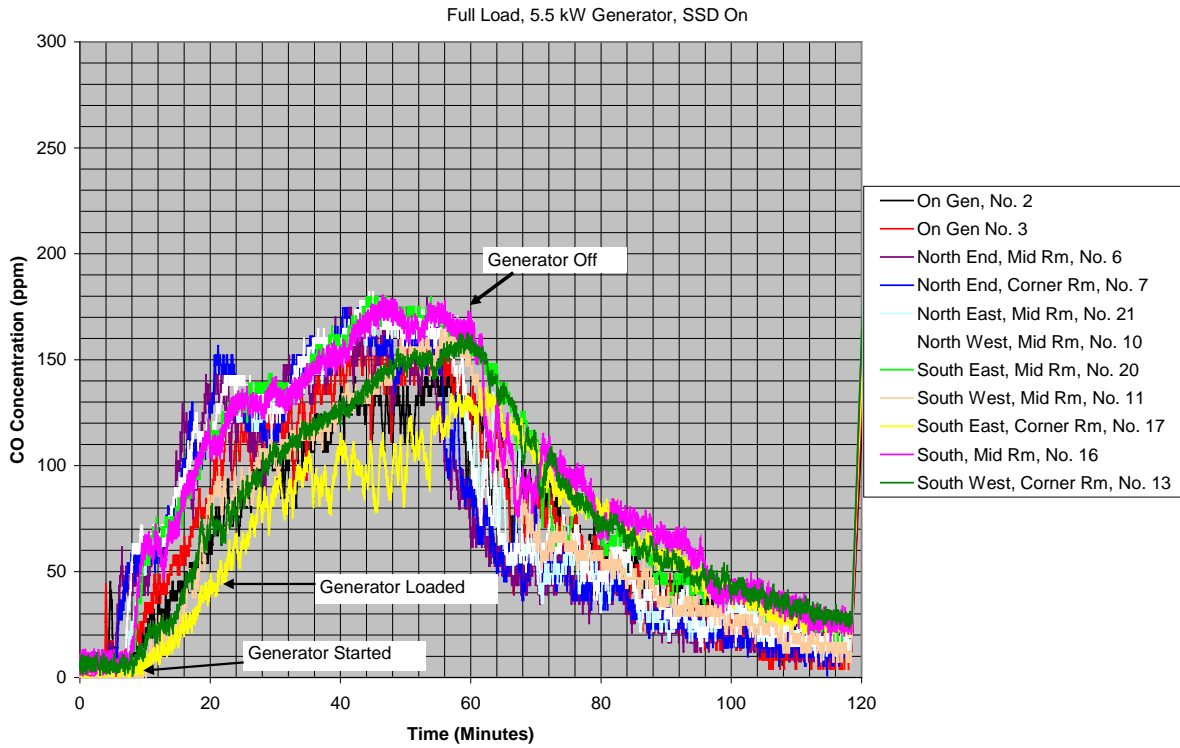
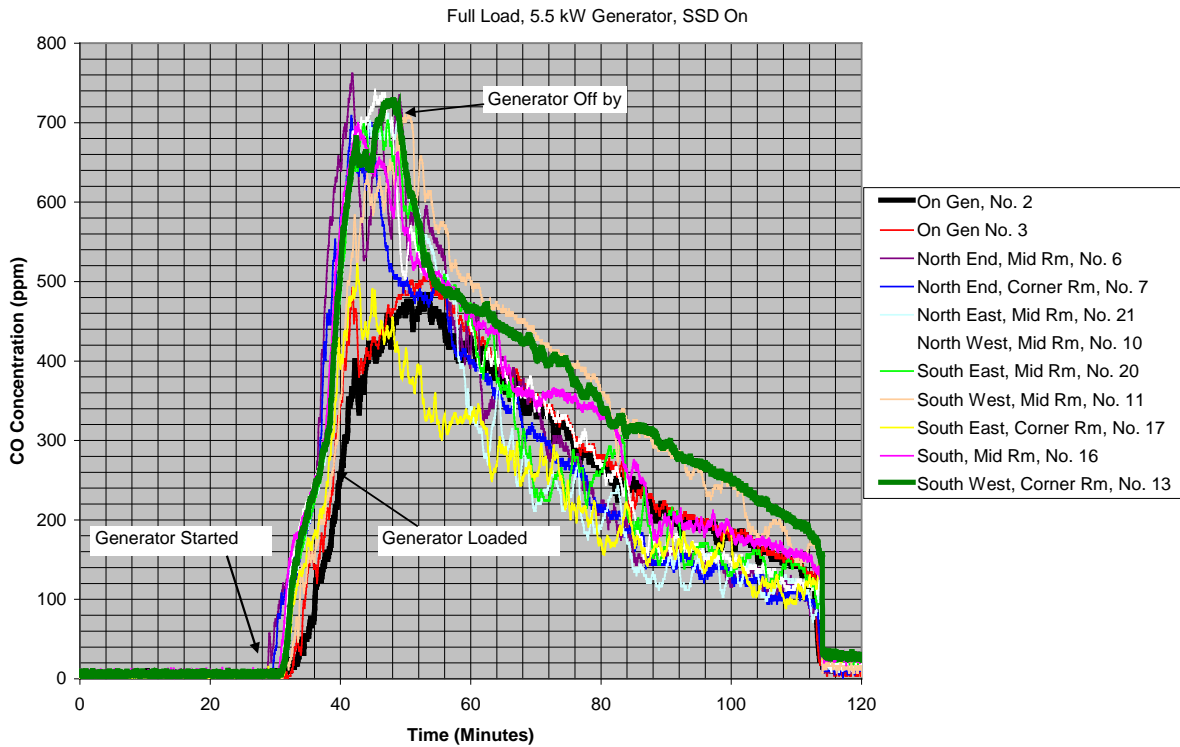
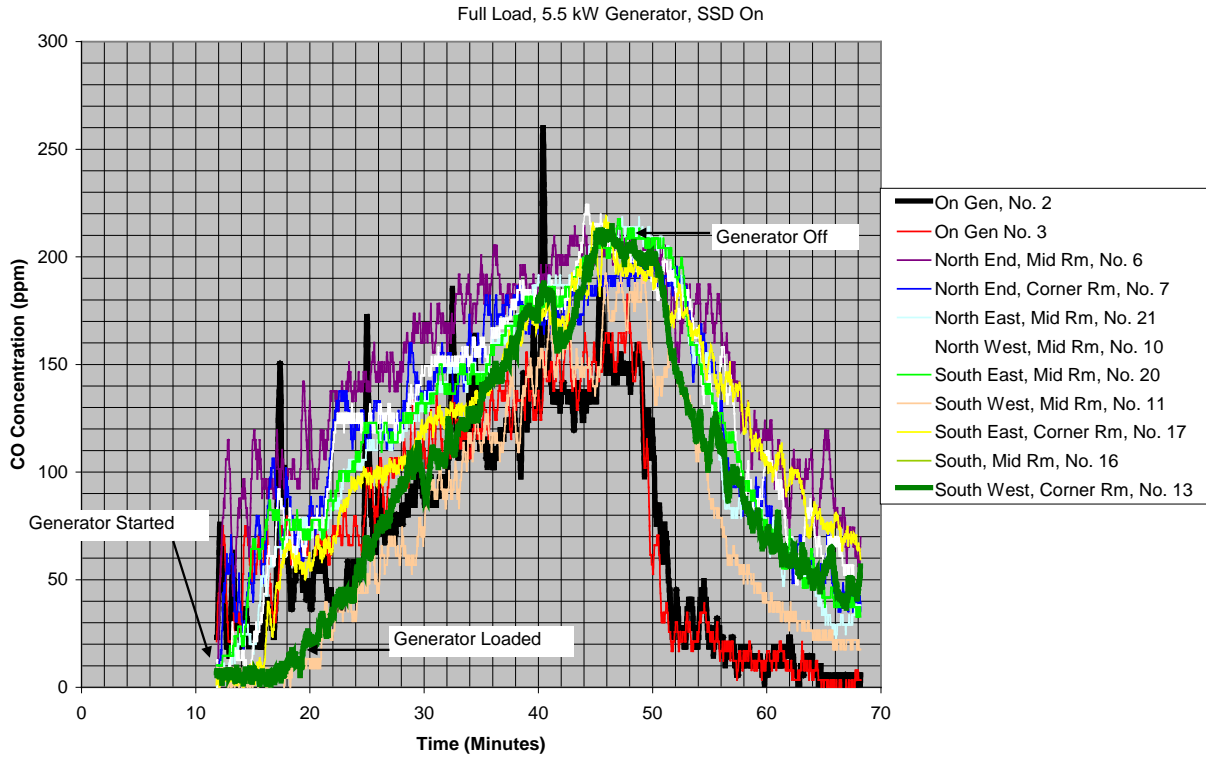


Figure C14: Inside TMS, Door Closed and Vents Open, SSD Test 3, Test ID 4b.1, 10/20/05



**Figure C15: Inside TMS, Open Door, Vents Open, SSD Test 5, Test ID 3b.1, 10/20/05**



**Figure C16: Under TMS, Door and Vents Closed, SSD Test 6, Test ID 6b.1, 10/27/05**

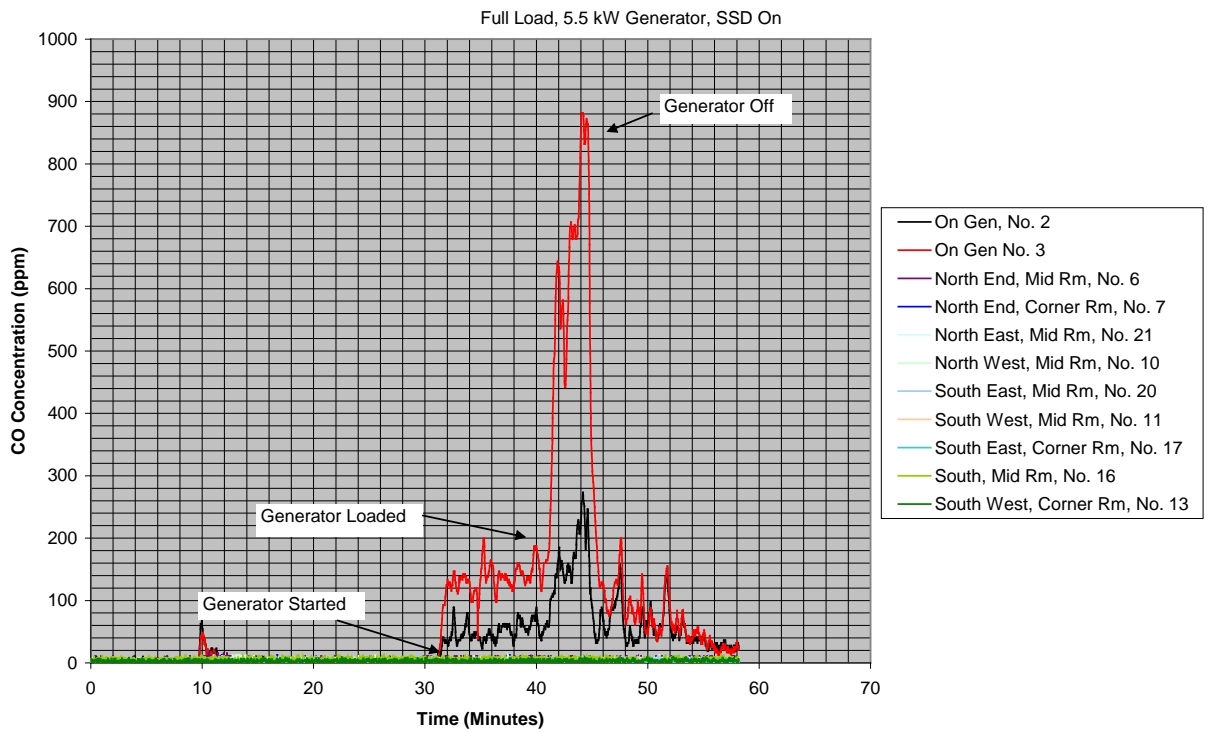




Figure C17: Two-Sided Shelter, Exhaust to TMS Wall, SSD Test 7, Test ID 2b.2, 10/31/05

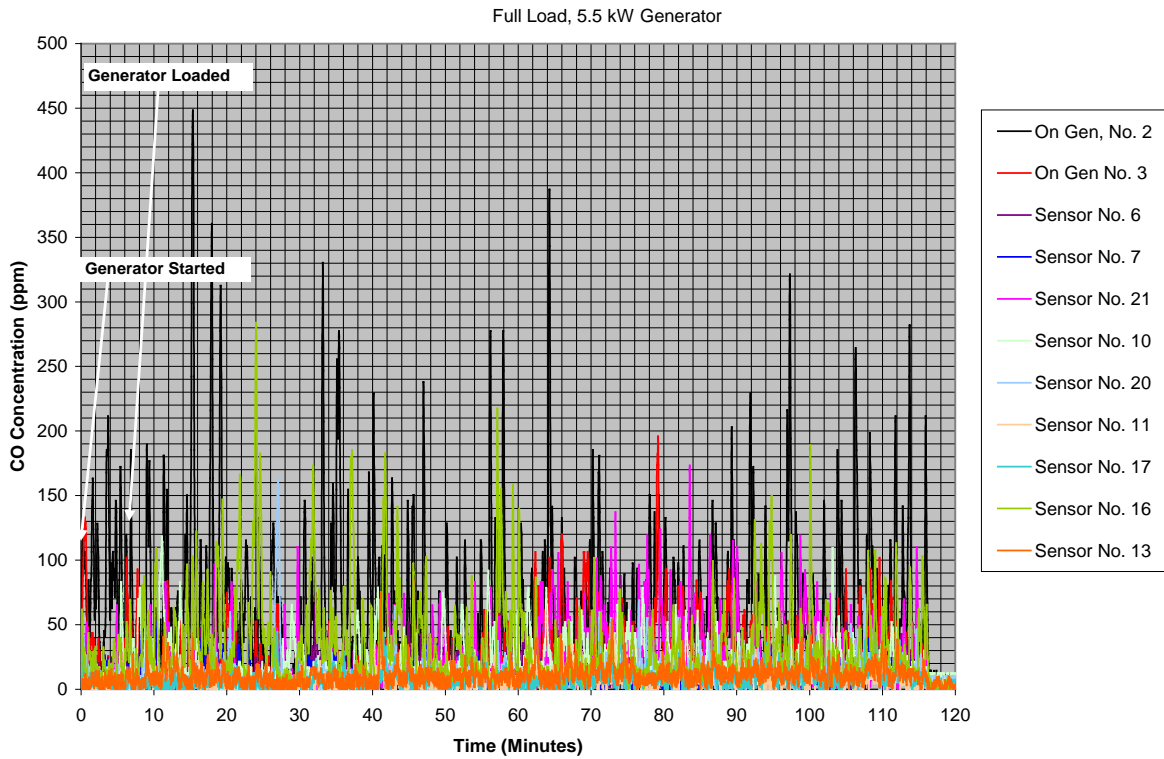


Figure C18: Two-Sided Shelter, Exhaust to Courtyard, SSD Test 8, Test ID 2b.1, 10/31/05

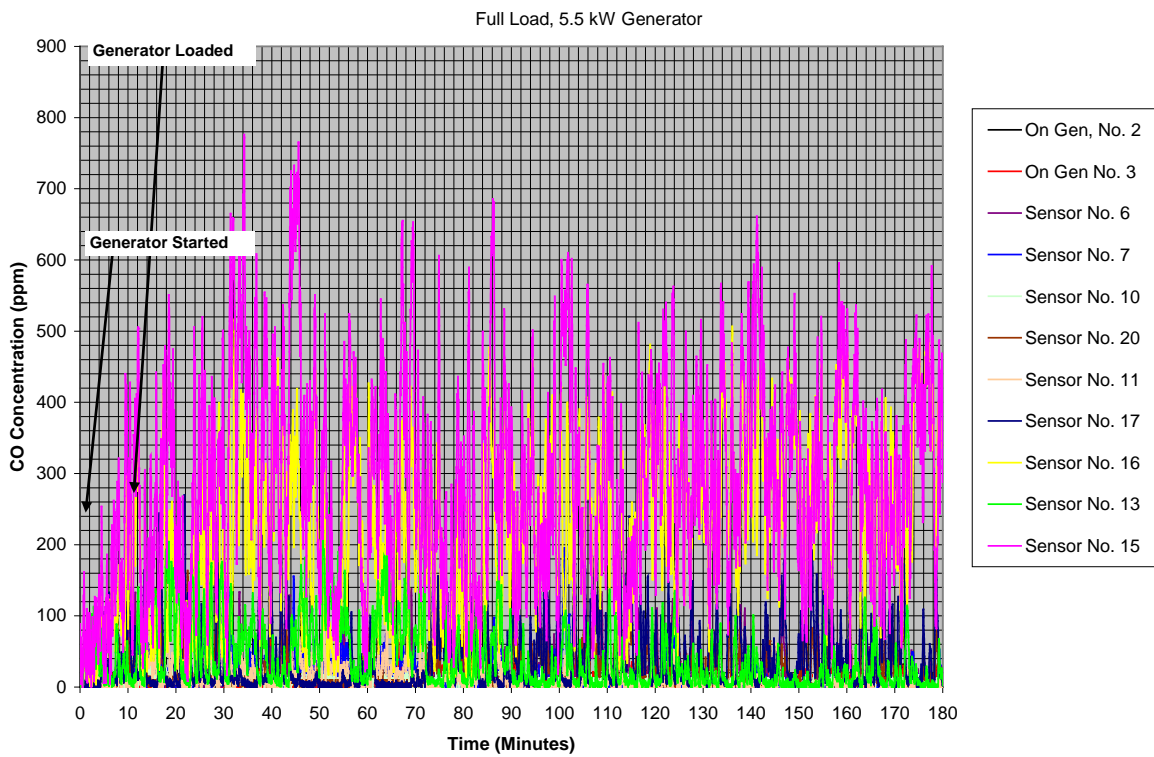


Figure C19: Center of Courtyard, SSD Test 9, Test ID 1b.1, 11/03/05

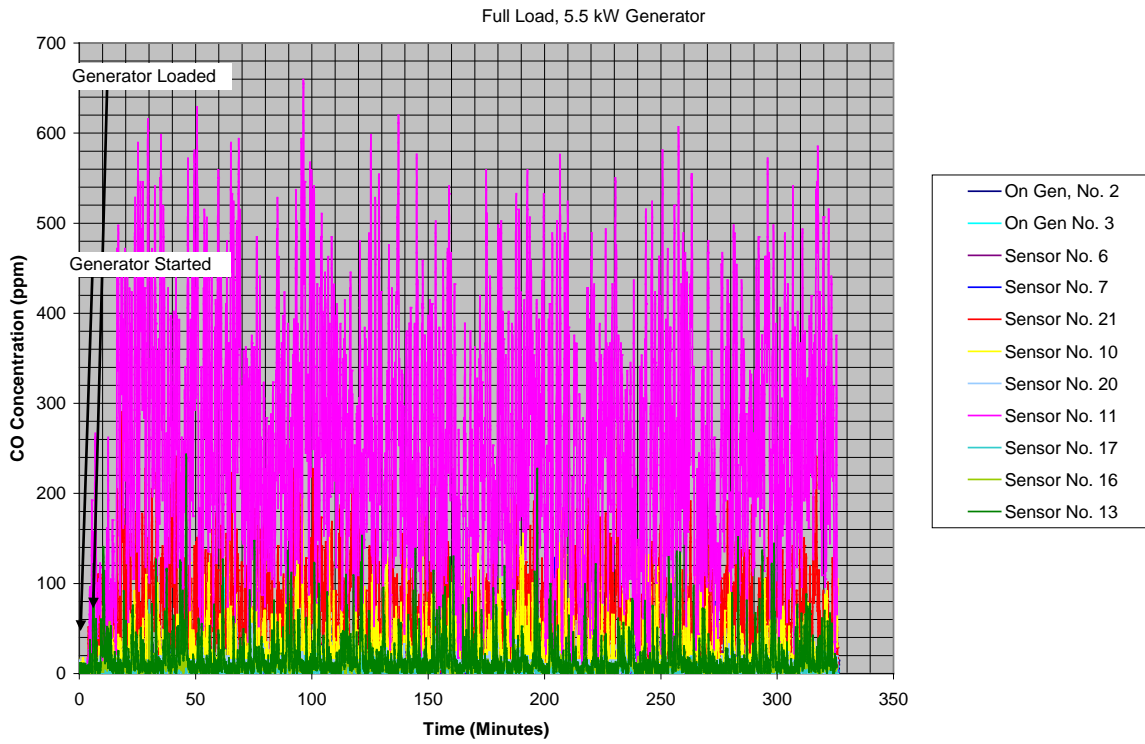
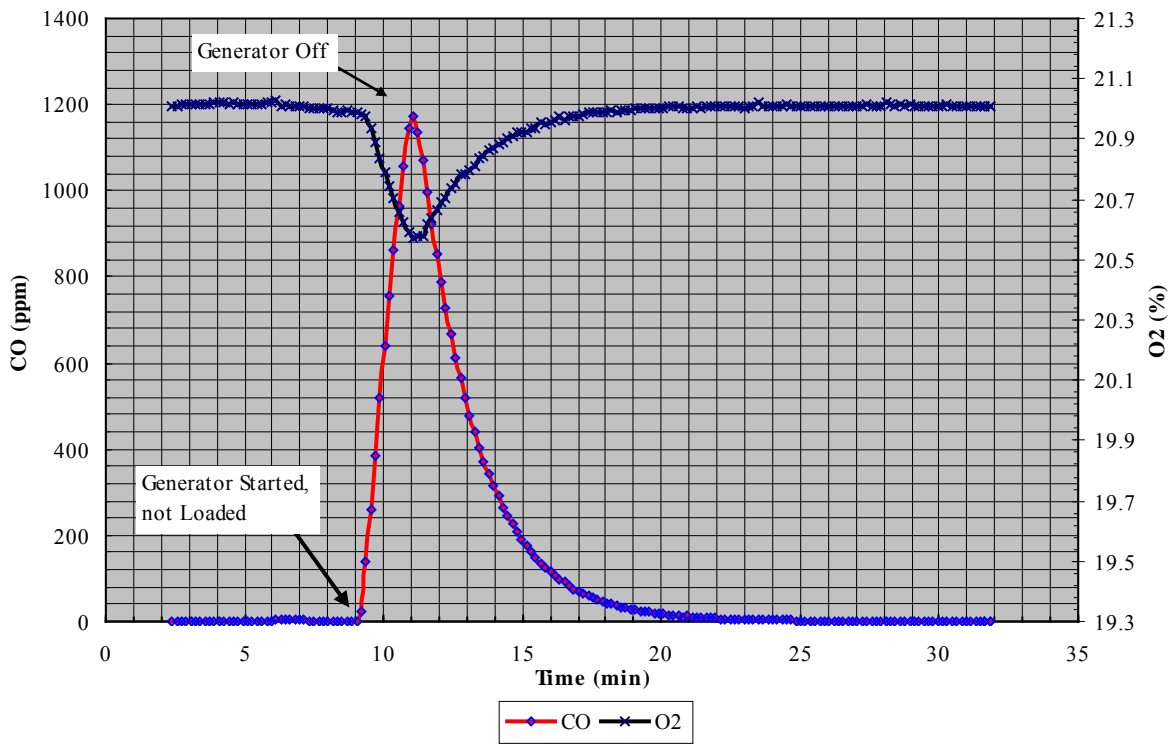


Figure C20: M-Chamber Test 1, SSD Test 10, Test ID 7b.1, 11/04/2005  
Air Exchange Rate = 29 ACH, Fully Loaded 5.5 kW Generator



## APPENDIX D: CO ALARM AND CO SENSOR TESTS

Residential CO alarms and CO sensors were used in various applications during the Phase 2 generator test program. To verify that the CO alarms were operating properly, most of the CO alarms were exposed to a calibration gas of known concentration or tested to the sensitivity requirement in UL 2034. In addition, the voltage output of the CO sensors relative to the CO concentration was verified at different CO concentrations.

### D-Chamber Test Setup

Some of the CO alarms were tested inside of a modified environmental test chamber (Lunaire, model CEO-932-4), referred to as the D-Chamber, which is located in Building G at the CPSC Laboratory. The interior volume of the D-Chamber is 0.91 m<sup>3</sup> (32 ft<sup>3</sup>), and the walls are constructed of stainless steel. The test chamber has both temperature control (0 to 99°C) and humidity control (20 to 96 percent RH). The chamber has been modified to allow for the injection of CO into the test chamber. Gas samples are obtained through six equal length lines, from six different locations inside of the chamber and are blended using a gas-mixing manifold. The rate of CO gas injection into the chamber is controlled using a Sierra Model 820 mass flow controller and adjustable rotometers.

The CO concentration versus time data were recorded using a data acquisition system (DAS), which consists of a personal computer, data acquisition interface hardware (Data Translation, USB Module 9806), and data acquisition software (LabTech). Per UL 2034, the CO injection system is designed to obtain the desired steady state CO concentration inside the test chamber within 3 minutes. The steady state CO concentration is then maintained at  $\pm 5$  ppm for the 100 ppm and 200 ppm tests, and  $\pm 10$  ppm for the 400ppm tests.

Staff used the D-Chamber DAS to record CO concentration data when evaluating alarm performance in a controlled environment. The D-Chamber DAS used LabTech<sup>TM</sup> software for data acquisition. In addition to obtaining the data electronically, test results were periodically recorded manually in a logbook during testing. Since simultaneous review and recording of results from the numerous CO sensors was difficult during testing, staff also used Gadwin PrintScreen 3.1<sup>TM</sup> screen capture software to record results.

### Model 1 CO Alarms

The Model 1 CO alarms were used as part of the Safety Shutoff Device (SSD). The performance of these CO alarms relative to the sensitivity requirement in UL 2034 was not verified prior to using them in the generator tests. Instead, staff performed a limited check of their ability to measure CO following all of the generator tests. Staff exposed the CO alarms to a 200ppm standard calibration gas while they were mounted outdoors. The results of these tests indicated that all of the digital displays on the CO alarms were within 30 percent of the 200ppm standard gas CO concentration. However, all of the displayed CO concentrations were lower than the 200-ppm concentration.<sup>1</sup>

---

<sup>1</sup> Geometry of CO alarm made outdoor exposure to calibration gas difficult. Thus, the results may have been slightly lowered because of dilution.

## **Model 2 CO Alarms**

The Model 2 CO alarms were used to measure the CO concentration during the generator tests that occurred outdoors and in the TMS. Prior to using the CO alarms, staff exposed the CO alarms to known CO concentrations inside the D-Chamber and compared the CO concentration shown on the CO alarm's digital display to the CO concentration measured with a laboratory grade CO analyzer. In addition, prior to all generator testing, staff tested five of the CO alarms that were to be mounted on the generator, according to sensitivity test specified in UL 2034 at CO concentrations of 70 ppm, 150 ppm, and 400 ppm. In all but one test, the CO alarm operation complied with the requirements of UL 2034 (one test failed by approximately 15 seconds).

After the pre-SSD tests, the five generator-mounted CO alarms and 17 additional CO alarms were tested for performance according to UL 2034, at a CO concentration of 150 ppm. Additionally, the 22 CO alarms were exposed to CO concentrations of approximately 60 to 100 ppm, 180 ppm, 400 ppm, and 800 ppm of CO prior to TMS testing. The continuous testing was performed to assess the accuracy of their digital display readings after they had been repeatedly exposed to CO during the generator tests.

After the final generator test, all CO alarms were exposed to a 200ppm CO standard calibration gas to verify their post-test operational capabilities. The CO alarms' digital displays were within 19 percent of the actual CO concentration in the comparison tests performed prior to the TMS testing. The CO alarms' digital displays were within 23 percent of the 200-ppm standard gas CO concentration in tests performed after all Phase 2 testing.

Results of these various tests are provided in tables D1 through D10.

**Model 2****Test Date: 5/20/2005****CO Alarm Performance Tests Completed Before Generator Testing Began****Table D1: CO Alarm Test Results at 400 ppm, UL 2034 CO Alarm Test (4-15 minutes acceptable alarm time)**

| CO Alarm No. | Alarm Time to Activate (minutes) | CO Alarm Reading at Alarm (ppm CO) | Analyzer Reading (ppm CO) | Chamber at Alarm |      |
|--------------|----------------------------------|------------------------------------|---------------------------|------------------|------|
|              |                                  |                                    |                           | Temp (C°)        | % RH |
| 1            | 5                                | 413                                | 401                       | 23               | 44   |
| 2            | 5                                | 423                                | 401                       | 23               | 44   |
| 3            | 5.25                             | 418                                | 401                       | 23               | 44   |
| 4            | 6.2                              | 396                                | 400                       | 23               | 44   |
| 5            | 3.75                             | 429                                | 400                       | 23               | 44   |

**Table D2: CO Alarm Test Results at 150 ppm, UL 2034 CO Alarm Test (10-50 minutes acceptable alarm time)**

| CO Alarm No. | Alarm Time to Activate (minutes) | CO Alarm Reading at Alarm (ppm CO) | Analyzer Reading (ppm CO) | Chamber at Alarm |      |
|--------------|----------------------------------|------------------------------------|---------------------------|------------------|------|
|              |                                  |                                    |                           | Temp (C°)        | % RH |
| 1            | 31.1                             | 156                                | 154                       | 24               | 40   |
| 2            | 30.75                            | 148                                | 153                       | 24               | 40   |
| 3            | 30.3                             | 146                                | 154                       | 24               | 40   |
| 4            | 32.4                             | 152                                | 155                       | 24               | 39   |
| 5            | 24.5                             | 165                                | 154                       | 23               | 42   |

**Test Date: 5/23/2005****Table D3: CO Alarm Test Results at 70 ppm UL 2034 CO Alarm Test (10-50 minutes acceptable alarm time)**

| CO Alarm No. | Alarm Time to Activate (minutes) | CO Alarm Reading at Alarm (ppm CO) | Analyzer Reading (ppm CO) | Chamber at Alarm |      |
|--------------|----------------------------------|------------------------------------|---------------------------|------------------|------|
|              |                                  |                                    |                           | Temp (C°)        | % RH |
| 1            | 89                               | 64                                 | 70                        | 24               | 41   |
| 2            | 93                               | 69                                 | 70                        | 24               | 40   |
| 3            | 98                               | 62                                 | 71                        | 25               | 40   |
| 4            | 98                               | 62                                 | 71                        | 25               | 40   |
| 5            | 82                               | 77                                 | 70                        | 23               | 44   |

**Model 2**

**Test Date: 8/11/2005**

**CO Alarm Performance Tests Completed After Outdoor Generator Pre-SSD Testing Completed**

**Table D4: CO Alarm Test Results at 150 ppm UL 2034 CO Alarm Test, Test Run 1**

(10-50 minutes acceptable alarm time)

| CO Alarm No. | Alarm Time to Activate (minutes) | CO Alarm Reading at Alarm (ppm CO) | Analyzer Reading (ppm CO) | Chamber at Alarm |      |
|--------------|----------------------------------|------------------------------------|---------------------------|------------------|------|
|              |                                  |                                    |                           | Temp (C°)        | % RH |
| 1            | 30.25                            | 153                                | 152                       | 23               | 65   |
| 2            | 31.1                             | 152                                | 152                       | 23               | 63   |
| 3            | 30.9                             | 152                                | 152                       | 23               | 63   |
| 4            | 32.25                            | 146                                | 152                       | 23               | 61   |
| 5            | 28.75                            | 159                                | 151                       | 22               | 63   |
| 6            | 31.9                             | 150                                | 152                       | 23               | 61   |
| 7            | 27.75                            | 171                                | 152                       | 24               | 60   |
| 8            | 31.1                             | 151                                | 152                       | 24               | 60   |
| 9            | 28.5                             | 162                                | 152                       | 24               | 60   |
| 10           | 30.0                             | 157                                | 152                       | 24               | 60   |
| 11           | 29.9                             | 157                                | 152                       | 24               | 60   |
| 12           | 28.0                             | 163                                | 152                       | 24               | 60   |
| 13           | 30.4                             | 155                                | 152                       | 22               | 69   |
| 14           | 28.8                             | 161                                | 152                       | 22               | 68   |
| 15           | 29.0                             | 161                                | 152                       | 22               | 68   |
| 16           | 27.75                            | 170                                | 152                       | 22               | 56   |
| 17           | 28.5                             | 162                                | 152                       | 22               | 62   |
| 18           | 30.1                             | 160                                | 151                       | 23               | 68   |
| 19           | 30.8                             | 153                                | 152                       | 23               | 67   |
| 20           | 29.8                             | 158                                | 151                       | 23               | 68   |
| 21           | 28.75                            | 162                                | 151                       | 22               | 67   |
| 22           | 29.25                            | 159                                | 151                       | 22               | 69   |

Model 2:Test Date: 8/10/2005

**CO Alarm Performance Tests Completed After Outdoor Generator Pre-SSD Testing Completed**

**Table D5: CO Alarm Digital Displays Compared with Rosemount Analyzer Reading (Alarms 7-10), Test Run 2**

|                           | <b>CO Concentration (ppm)</b> |            |            |            |
|---------------------------|-------------------------------|------------|------------|------------|
| <b>Rosemount Analyzer</b> | <b>97</b>                     | <b>176</b> | <b>380</b> | <b>796</b> |
| CO Alarm No. 7            | 107                           | 187        | 425        | 921        |
| CO Alarm No. 8            | 98                            | 175        | 385        | 828        |
| CO Alarm No. 9            | 95                            | 185        | 420        | 910        |
| CO Alarm No. 10           | 99                            | 179        | 405        | 879        |

**Table D6: CO Alarm Digital Displays Compared with Rosemount Analyzer Reading (Alarms 5, 6, 11, 12), Test Run 3**

|                           | <b>CO Concentration (ppm)</b> |            |            |            |
|---------------------------|-------------------------------|------------|------------|------------|
| <b>Rosemount Analyzer</b> | <b>99</b>                     | <b>177</b> | <b>442</b> | <b>780</b> |
| CO Alarm No. 5            | 106                           | 192        | 478        | 861        |
| CO Alarm No. 6            | 93                            | 174        | 445        | 804        |
| CO Alarm No. 11           | 94                            | 178        | 465        | 844        |
| CO Alarm No. 12           | 99                            | 187        | 492        | 892        |

**Table D7: CO Alarm Digital Displays Compared with Rosemount Analyzer Reading (Alarms 13-16), Test Run 4**

|                           | <b>CO Concentration (ppm)</b> |            |            |            |
|---------------------------|-------------------------------|------------|------------|------------|
| <b>Rosemount Analyzer</b> | <b>65</b>                     | <b>167</b> | <b>374</b> | <b>887</b> |
| CO Alarm No. 13           | 62                            | 176        | 395        | 870        |
| CO Alarm No. 14           | 64                            | 173        | 408        | 878        |
| CO Alarm No. 15           | 69                            | 172        | 400        | 863        |
| CO Alarm No. 16           | 77                            | 178        | 412        | 884        |

**Table D8: CO Alarm Digital Displays Compared with Rosemount Analyzer Reading (Alarms 1-4), Test Run 5**

|                           | <b>CO Concentration (ppm)</b> |            |            |            |
|---------------------------|-------------------------------|------------|------------|------------|
| <b>Rosemount Analyzer</b> | <b>88</b>                     | <b>173</b> | <b>397</b> | <b>765</b> |
| CO Alarm No. 1            | 99                            | 184        | 423        | 841        |
| CO Alarm No. 2            | 83                            | 175        | 424        | 844        |
| CO Alarm No. 3            | 89                            | 178        | 412        | 827        |
| CO Alarm No. 4            | 92                            | 168        | 405        | 808        |

**Table D9: CO Alarm Digital Displays Compared with Rosemount Analyzer Reading (Alarms 17-22), Test Run 6**

|                           | <b>CO Concentration (ppm)</b> |            |            |            |
|---------------------------|-------------------------------|------------|------------|------------|
| <b>Rosemount Analyzer</b> | <b>88</b>                     | <b>172</b> | <b>408</b> | <b>788</b> |
| CO Alarm No. 17           | 86                            | 183        | 448        | 902        |
| CO Alarm No. 18           | 88                            | 180        | 443        | 886        |
| CO Alarm No. 19           | 90                            | 169        | 427        | 853        |
| CO Alarm No. 20           | 86                            | 177        | 433        | 866        |
| CO Alarm No. 21           | 89                            | 190        | 459        | 923        |
| CO Alarm No. 22           | 85                            | 184        | 456        | 922        |

**Table D10: CO Alarm Reading after Exposure to 200 ppm Calibration Gas, Test Run 7**

| CO Alarm No. | CO Alarm Reading (ppm) | CO Alarm Description                |
|--------------|------------------------|-------------------------------------|
|              |                        |                                     |
| 1            | 139                    | Incorporated into SSD, on Generator |
| 2            | 139                    | Incorporated into SSD, on Generator |
| 3            | 167                    | Incorporated into SSD, on Generator |
| 4            | 161                    | Incorporated into SSD, on Generator |
| 5            | Bad Alarm              | Mounted on Stanchion                |
| 6            | 182                    | Mounted on Stanchion                |
| 7            | 195                    | Mounted on Stanchion                |
| 8            | 204                    | Mounted on Stanchion                |
| 9            | 246                    | Mounted on Stanchion                |
| 10           | 199                    | Mounted on Stanchion                |
| 11           | 189                    | Mounted on Stanchion                |
| 12           | 192                    | Mounted on Stanchion                |
| 13           | 193                    | Mounted on Stanchion                |
| 14           | 180                    | Mounted on Stanchion                |
| 15           | 190                    | Mounted on Stanchion                |
| 16           | 223                    | Mounted on Stanchion                |
| 17           | 190                    | Mounted on Stanchion                |
| 18           | 155                    | Mounted on Stanchion                |
| 19           | 225                    | Mounted on Stanchion                |
| 20           | 176                    | Mounted on Stanchion                |
| 21           | 193                    | Mounted on Stanchion                |
| 22           | 169                    | Mounted on Stanchion                |

**CO Sensors**

The CO sensors were used to measure the CO concentration during the generator tests that occurred outdoors and in the TMS. Prior to and following testing, the sensors underwent calibration and/or control checks of their accuracy. Calibration of the 2,000 ppm sensors in the M-Chamber involved using a Rosemount NGA 2000 gas analyzer (uncertainty < 2 percent, non-dispersive infrared (NDIR) technology), with CO gas injected at 20 different CO concentrations over the sensor range, up to 1900 ppm. An expression describing how well the data fit a line is the R<sup>2</sup> term, where R is the correlation coefficient. An R<sup>2</sup> value of 1.0 indicates that the line obtained by linear regression fit the data perfectly. The R<sup>2</sup> for the 2,000-ppm sensors ranged from 0.9999 to 1.0. Staff determined that the maximum error of the sensors was approximately 2.4 percent, at approximately 80 °F ± 5 °F. However, by comparing the temperatures that occurred during the generator tests to the manufacturer’s performance curve, staff estimated that additional uncertainty due to temperature variation was -5 percent and +10 percent for the 2,000 ppm sensors.

Calibration of the 20,000 ppm sensors involved injecting CO at up to 34 different CO concentrations, up to 7,400 ppm. Analyzer range limitations limited calibration to 7,400 ppm. The R<sup>2</sup> value for the 20,000 ppm sensors ranged from 0.998 to 0.9999. Staff determined the maximum error of the 20,000 ppm sensors to be approximately 3.5 percent, at approximately 80° ± 5° F. Additional uncertainty due to temperature variation during testing was -5 percent and +8 percent for the 20,000 ppm sensors, up to approximately 7,400 ppm.